



CYBER 180

810 and 830 Computer Systems

Hardware Operator's Guide

810 Computer System
810A Computer System
65810 Computer System
830 Computer System
830A Computer System
65830 Computer System

60469440

LIST OF EFFECTIVE PAGES

New features, as well as changes, deletions, and additions to information in this manual, are indicated by bars in the margins or by a dot near the page number if the entire page is affected. A bar by the page number indicates pagination rather than content has changed.

PAGE	REV	PAGE	REV	PAGE	REV	PAGE	REV	PAGE	REV
Front Cover	C	4-3	A						
Title Page	C	4-4	A						
2	C	4-5	A						
3/4	C	Divider	A						
5/6	C	5-1	A						
7	B	5-2	B						
8	B	5-3	A						
Divider	A	5-4	A						
1-1	C	5-5	A						
1-2	C	5-6	A						
Divider	A	Divider	A						
2-1	C	6-1	C						
2-2	A	Divider	A						
2-3	A	7-1	C						
2-4	A	Divider	A						
2-5	A	8-1	A						
2-6	B	8-2	A						
2-7	B	8-3	A						
2-8	B	8-4	A						
2-9	B	Comment							
2-10	B	Sheet	C						
2-11	B	Back							
2-12	B	Cover	A						
2-13	B								
2-14	B								
2-15	B								
2-16	B								
2-17	B								
2-18	B								
Divider	A								
3-1	B								
3-2	B								
3-3	B								
3-4	B								
3-5	B								
3-6	B								
Divider	A								
4-1	A								
4-2	C								

PREFACE

This guide provides operating instructions for the CONTROL DATA® CYBER 180 Model 810, 810A, 65810, 830, 830A and 65830 Computer Systems. It familiarizes the operator with the computer system controls and indicators, and the displays used in system start-up, power-down, and recovery procedures (not operating system procedures). For details of the operation of CDC standard operating systems, refer to the applicable operator's guide.

Job requirements of the computer system operator may vary from one site to another depending on preservice maintenance agreements. Use this manual in conjunction with any policies and procedures established for your particular site.

RELATED PUBLICATIONS

The following manuals contain additional information which may prove useful:

<u>Control Data Publication</u>	<u>Publication Number</u>
CYBER 180 Model 810 and 830 Computer Systems Hardware Reference Manual	60469420
NOS/BE Operator's Guide	60493900
NOS Version 2 Operations Handbook	60459310
CYBER 180 Supermini Operations Handbook	60459850
Maintenance Software Library (MSL) 15X Reference Manual	60456530
Concurrent Maintenance Library (CML) Reference Manual	60455980
CYBER Initialization Package (CIP) User's Handbook	60457180
NOS/VE Operations Handbook	60463914
721-21/31 Owner's Manual	62950101

DISCLAIMER

This product is intended for use only as described in this manual. Control Data cannot be responsible for the proper functioning of undescribed features or parameters.

WARNING

This equipment generates, uses and can radiate radio frequency energy and, if not installed and used in accordance with the instructions manual, may cause interference to radio communications. It has been tested and found to comply with the limits for a Class A computing device pursuant to Subpart J of Part 15 of the FCC Rules which are designed to provide reasonable protection against such interference when operated in a commercial environment. Operation of this equipment in a residential area is likely to cause interference in which case the user, at his own expense, will be required to take whatever measures may be required to correct the interference.

1941
1942
1943
1944
1945
1946
1947
1948
1949
1950
1951
1952
1953
1954
1955
1956
1957
1958
1959
1960
1961
1962
1963
1964
1965
1966
1967
1968
1969
1970
1971
1972
1973
1974
1975
1976
1977
1978
1979
1980
1981
1982
1983
1984
1985
1986
1987
1988
1989
1990
1991
1992
1993
1994
1995
1996
1997
1998
1999
2000
2001
2002
2003
2004
2005
2006
2007
2008
2009
2010
2011
2012
2013
2014
2015
2016
2017
2018
2019
2020
2021
2022
2023
2024
2025

CONTENTS

1. GENERAL DESCRIPTION	1-1	Mainframe Reconfiguration	3-4
Computer System	1-1	PP Reconfiguration	3-4
Operating System	1-1	Reconfiguring 10-PP Systems	3-4
CYBER Initialization Package (CIP)	1-1	Reconfiguring 20-PP Systems	3-5
Maintenance Software Library (MSL)	1-3	Central Memory Reconfiguration	3-6
Common Maintenance Software Executive (CMSE)	1-3		
Tests and Diagnostics	1-3		
Command Buffers	1-3		
Common Test and Initialization Module (CTI)	1-3	4. STARTUP PROCEDURES	4-1
Hardware Initialization and	1-3	Power Application Procedures	4-1
Verification Software (HIVS)	1-3	Local Control (No SPCP)	4-1
		Local Control (SPCP)	4-1
		SPCP Control	4-1
		Remote Control (SPCP)	4-1
		Deadstart Procedures	4-1
		Power Recovery Deadstart Program	4-4
		Calendar Clock	4-5
2. OPERATOR CONTROLS AND INDICATORS	2-1		
System Power Controls And Indicators	2-1	5. PROBLEM DETERMINATION	5-1
Fault Warning And Shutdowns	2-1	Structured Analysis Method (SAM)	5-1
Central Memory Controls	2-10	Maintenance Procedures	5-2
Display Station Controls	2-10	Remote Maintenance Communications	5-6
Display Units	2-10		
Display Controls	2-10	6. EMERGENCY OPERATING INSTRUCTIONS	6-1
Keyboard	2-14		
Keyboard Functions	2-14	7. POWER DOWN	7-1
Tabletop Model Keyboard Functions	2-14	Local Control	7-1
Deadstart Options Display	2-17	SPCP Control	7-1
Initial Deadstart Display	2-17		
Deadstart Programs	2-17	8. OPERATOR SUPPLIES	8-1
Editing Programs	2-18	Preservice Request Form	8-1
Battery	2-18	Preservice Request Form	8-2
Deadstarting The PPs	2-18		
Help	2-18		
3. INITIAL ADJUSTMENTS	3-1		
Deadstart Programs	3-1		
Coldstart Programs	3-1		
Warmstart	3-1		

FIGURES

1-1	Hardware Configuration	1-2	2-13	Deadstart Options Display	2-17
2-1	Mainframe Component Locations	2-1	3-1	Initial Deadstart Display	3-1
2-2	400-Hz System Power Control Panel	2-3	3-2	PP Reconfiguration RP=0	3-5
2-3	Cabinet Power Control	2-4	3-3	PP Reconfiguration RP=3	3-5
2-4	Blower/Charger Switch and Circuit Breakers	2-5			
2-5	Logic Power Supply Controls	2-6	5-1	HIVS Display	5-3
2-6	Voltmeter Controls	2-7	5-2	MSL Deadstart Display	5-4
2-7	System Fault Controls	2-8	5-3	CMSE A Display Header (21-Inch Model)	5-4
2-8	Two Port Mux Box	2-9	5-4	CMSE B Display Header	5-5
2-9	Display Station Controls (21-Inch Model)	2-11	5-6	CH/PP Display (Tabletop Model)	5-5
2-10	Tabletop Display Station	2-12	5-5	Test and Diagnostic Message Display	5-5
2-11	21-Inch Keyboard	2-15			
2-12	Tabletop Keyboard	2-16	8-1	Preservice Request Form	8-2

TABLES

2-1	400-Hz SPCP Controls and Indicators	2-2	2-9	Display Station Controls (21-Inch Model)	2-11
2-2	Cabinet Power Control	2-4	2-10	Display Controls (Tabletop Model)	2-13
2-3	Blower/Charger Switch and Circuit Breakers		2-11	21-Inch Model CMSE Keyboard Functions	2-15
		2-5	2-12	Tabletop Model CMSE Keyboard Functions	2-16
2-4	Logic Power Supply Controls	2-6			
2-5	Voltmeter Controls	2-7	3-1	Deadstart Programs for Coldstart	3-2
2-6	System Fault Controls	2-8	3-2	Deadstart Program for Warmstart	3-3
2-7	Two Port Mux Box Controls	2-9	3-3	CM Reconfiguration	3-6
2-8	CM Configuration Switches	2-10			

PROCEDURES

3-1	Reconfigure PPs	3-5	4-9	Deadstart Procedure, Warmstart	4-4
3-2	Reconfigure Central Memory	3-6	4-10	Power On Initialization	4-4
4-1	Power Application, Initial Startup or Recovery	4-1	5-1	Run Hardware Initialization and Verification Sequence (HIVS)	5-3
4-2	Power Application, Normal Condition	4-1	5-2	Load Off-Line Maintenance Software	5-3
4-3	Reset to Initial Deadstart Display	4-2	5-3	Run Command Buffers	5-5
4-4	Entering a Deadstart Program	4-2	5-4	Display Command Buffer Name Table	5-5
4-5	Deadstart Procedure, Coldstart (ISMT Subsystem)	4-2	5-5	Establish Remote Maintenance Communication Using RTD	5-6
4-6	Deadstart Procedure, Coldstart (ISD Subsystem)	4-3	6-1	Emergency Power Removal	6-1
4-7	Deadstart/Procedure, Coldstart (66X/7152 Tape Controller from Tape)	4-3	6-2	Audible Alarm	6-1
4-8	Deadstart Procedure, Coldstart (844/7152 Disk Controller from Disk Pack)	4-3	7-1	Power Removal, Normal Condition	7-1

SAM LISTS

5-1	Operating System Error Messages	5-1	5-3	Power/Cooling Warning Message or Failure Conditions	5-2
5-2	Deadstart Error Messages	5-2			

SECTION 1

GENERAL DESCRIPTION

This section introduces the components of the CDC® CYBER 180 Models 810, 810A, 65810, 830, 830A and 65830 computer systems, the operating system, and the maintenance software library (MSL) 151.

COMPUTER SYSTEM

Models 810, 810A, 65810, 830, 830A and 65830 are medium-scale, high-speed computer systems for both business and scientific applications. They include the following units:

- Central processor (CP)
- Central memory (CM)
- Input/output unit (IOU)
- Display station

The hardware configuration includes a display station and a cabinet for the CP, CM, and IOU (figure 1-1). The cabinet contains a logic chassis with plug-in circuit boards, a forced air cooling unit to cool the logic chassis, an ac/dc control section with voltage margin testing facilities, and dc power supplies.

The power distribution controls and indicators and the deadstart displays are described in section 2 of this guide. For further information about the hardware, refer to the CYBER 180 Models 810, 810A, 65810, 830, 830A and 65830 Hardware Reference Manual.

The display station provides a visual, alphanumeric readout for the computer and a keyboard for data entry (figure 1-1). Two models of display station are available: a 21-inch floor model with a 21-inch screen, and a tabletop model with a 15-inch screen. Some operating systems support the 21-inch model only.

Computer system software uses the display screen to bring information to your attention. You can respond to or instruct the computer system software by entering information via the console keyboard.

Display and command formats vary with the software currently being executed. Refer to the applicable operating system (OS) operator's guide for operator/system communication.

This guide provides basic instructions for operating the display station when the common maintenance software executive (CMSE) program controls the display. Display station controls are described in section 2 of this guide.

OPERATING SYSTEM

This guide assumes you use a standard CDC-supported operating system which functions with the common test and initialization module (CTI) and the hardware initialization and verification software (HIVS).

This guide includes some of the basic operating system deadstart and recovery procedures. For complete operating instructions, refer to the applicable operating system operator's guide.

If your site has purchased a Control Data Corporation maintenance agreement which provides for use of the Concurrent Maintenance Library (CML) with the operating system, refer to the CML Reference Manual for a description of CML features and capabilities.

The CTI loads the operating system. Procedures for using CTI are described in sections 4 and 5 of this guide.

CYBER INITIALIZATION PACKAGE (CIP)

A unique release tape called the CYBER Initialization Package (CIP) is created for each model of computer system. Sites with a maintenance contract receive a CIP tape that contains microcode, error interface (EI), CTI, CMSE, and selected MSL programs, command buffers, and utility routines. Sites without a maintenance contract receive a CIP tape that contains microcode, EI, CTI, CMSE, and a subset of MSL tests and utilities called HIVS. Refer to CIP User's Handbook for more information.

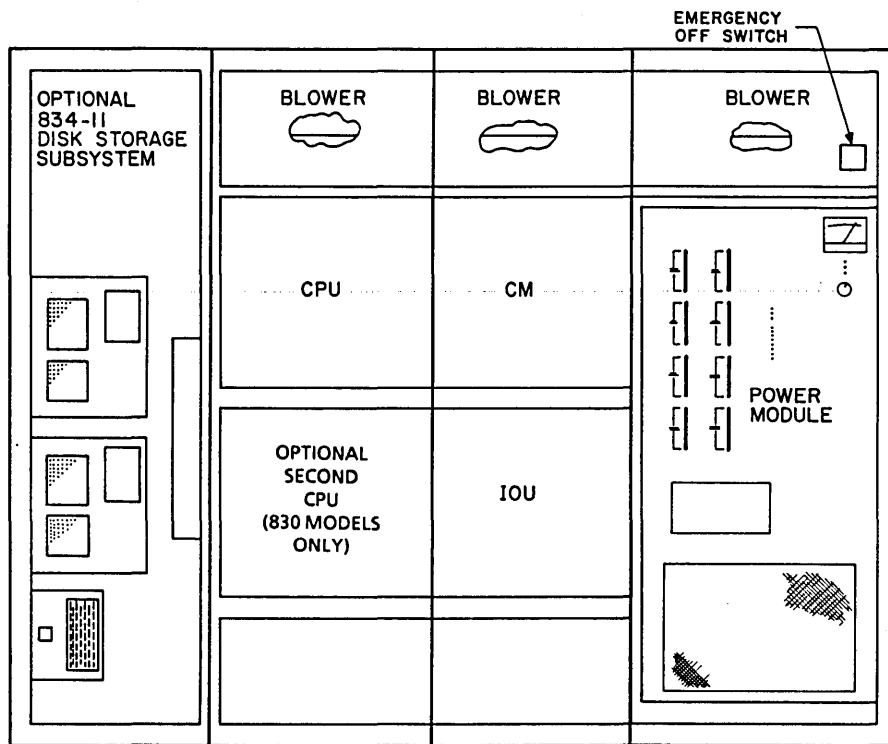

CABINET-FRONT VIEW

CI034

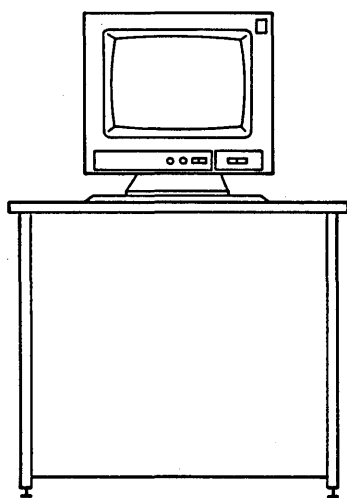

15-INCH TABLETOP DISPLAY STATION

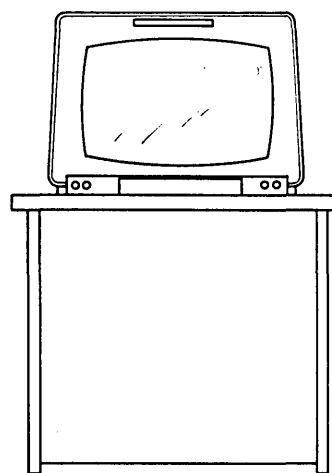

21-INCH FLOOR DISPLAY STATION

Figure 1-1. Hardware Configuration

MAINTENANCE SOFTWARE LIBRARY (MSL)

The MSL 151 consists of a set of tests and diagnostics which aid in identification and isolation of defective components of the computer system. The MSL is divided into the following parts:

- Common maintenance software executive (CMSE)
- Tests and diagnostics
- Command buffers

The operating system does not concurrently share the computer system with MSL as it does with CML. Thus, MSL operation is completely independent of the operating system (off-line).

COMMON MAINTENANCE SOFTWARE EXECUTIVE (CMSE)

CMSE controls MSL activity and provides for off-line monitoring from either a local or remote display station. CMSE also provides display facilities, a keyboard command structure, a loading capability, and diagnostic sequencing. CMSE can be initialized following a short or long deadstart or extended deadstart using CTI.

TESTS AND DIAGNOSTICS

The MSL contains a set of tests and diagnostics which test the many components of the computer system for correct operation, monitor system status and, in some cases, isolate system faults. The specific MSL tests provided at your site depend on the Control Data maintenance services contract in effect.

COMMAND BUFFERS

Command buffers enable a user to load and execute a series of tests and to set parameters. Procedures for using command buffers to run tests and diagnostics are described in section 5 of this guide.

COMMON TEST AND INITIALIZATION MODULE (CTI)

The CTI performs hardware initialization and represents a standardized human interface for loading either the operating system or CMSE. CTI consists of a set of displays from which the operator selects the desired method for deadstarting. The CTI process usually includes some input/output unit (IOU) testing and hardware initialization. See the CIP User's Handbook for more information.

HARDWARE INITIALIZATION AND VERIFICATION SOFTWARE (HIVS)

The HIVS is a basic subset of MSL tests which performs confidence testing of the system. The HIVS module exists on the CIP installation tape for sites that do not have a maintenance agreement for MSL.

SECTION 2

OPERATOR CONTROLS AND INDICATORS

This section illustrates and defines the functions of system controls, indicators, and deadstart displays. Figure 2-1 shows the general location of main components located in the computer cabinet.

indicators of the optional wall-mounted system power control panel (SPCP).

SYSTEM POWER CONTROLS AND INDICATORS

FAULT WARNING AND SHUTDOWNS

Figures 2-2 through 2-4 and tables 2-1 through 2-3 illustrate and define the cabinet-mounted power controls and indicators, and the controls and

Sensors within the system monitor site room, rectifier heat-sink, and logic chassis temperatures. These monitoring devices protect the system by producing visible alarms or status signals, or by removing system or cabinet power.

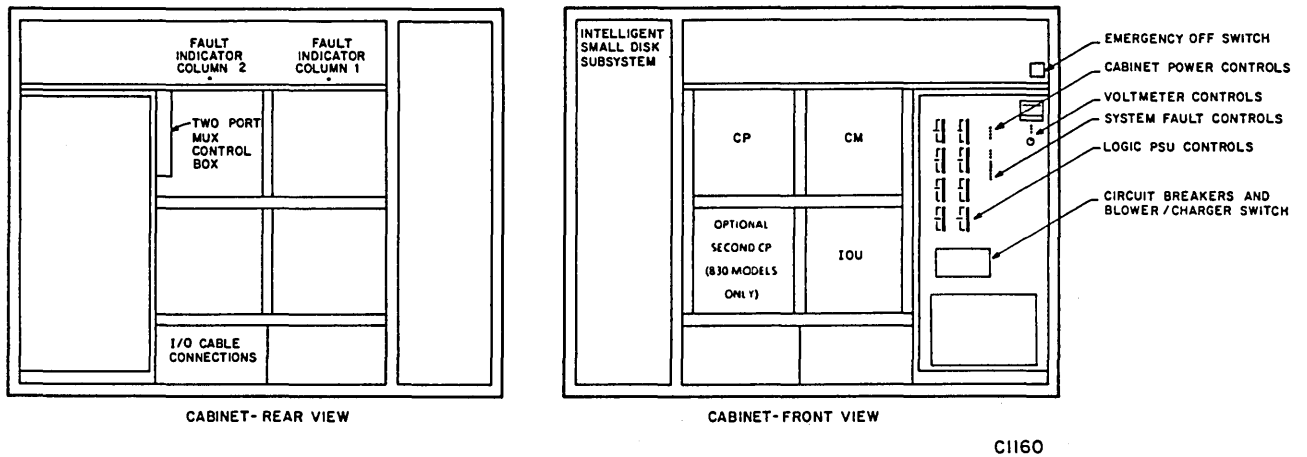

Figure 2-1. Mainframe Component Locations

TABLE 2-1. 400-Hz SPCP CONTROLS AND INDICATORS

Panel Marking/ Description	Function	Panel Marking/ Description	Function
SYSTEM DISCONNECT ON/OFF Toggle switch*	Applies single-phase 50/60-Hz power to SPCP from power source via wall-mounted emergency off switch.		REMOTE 2 - System is controlled by master CYBER 170/815, 825, or 835.
POWER AVAILABLE Indicator light	Indicates 50/60-Hz power is present at SPCP and SYSTEM DISCONNECT switch is ON.	STOP Pushbutton (latching)	REMOTE 3 - Not used. Removes 50/60-Hz power from system MG, SPCP fault warning and shutdown circuits, and peripheral equipment. Removes 400-Hz power from cabinets; occurs in all modes.
REMOTE ENABLE LOCAL START Pushbutton (momentary)	In local mode, unlatches STOP switch and applies 50/60-Hz power to system motor-generator (MG), SPCP fault warning and shutdown circuits, and peripheral equipment. Applies 400-Hz power from system MG to cabinets. In any remote mode, unlatch STOP switch; remote control point then performs functions listed above.	POWER ON Indicator light	Indicates conditions for POWER AVAILABLE indicator light are present, REMOTE ENABLE/LOCAL START switch has been pressed, and 50/60-Hz power has been applied throughout the system, either locally or remotely.
OFF/LOCAL/REMOTE Rotary switch, keylock	Selects control point for application of 50/60-Hz and 400-Hz power to system: OFF - System power cannot be applied. LOCAL - Local SPCP control. REMOTE 1 - System is controlled by master CYBER 170/700, or SPCP for peripherals shared by master CYBER 170/700 and slave CYBER 170/815, 825, or 835.	400 HZ VOLTAGE Meter VOLTAGE ADJUST Rheostat TIME METER Digital meter	Indicates percentage deviation of system MG output from nominal level (120 V line-to-neutral, 208 V line-to-line). Indication is average of the three 400-Hz lines. Adjusts system MG output voltage ± 5 percent from nominal level (refer to 400-Hz voltage preceding). Indicates total MG running time.
* Leave this switch ON (up position) under normal conditions.			

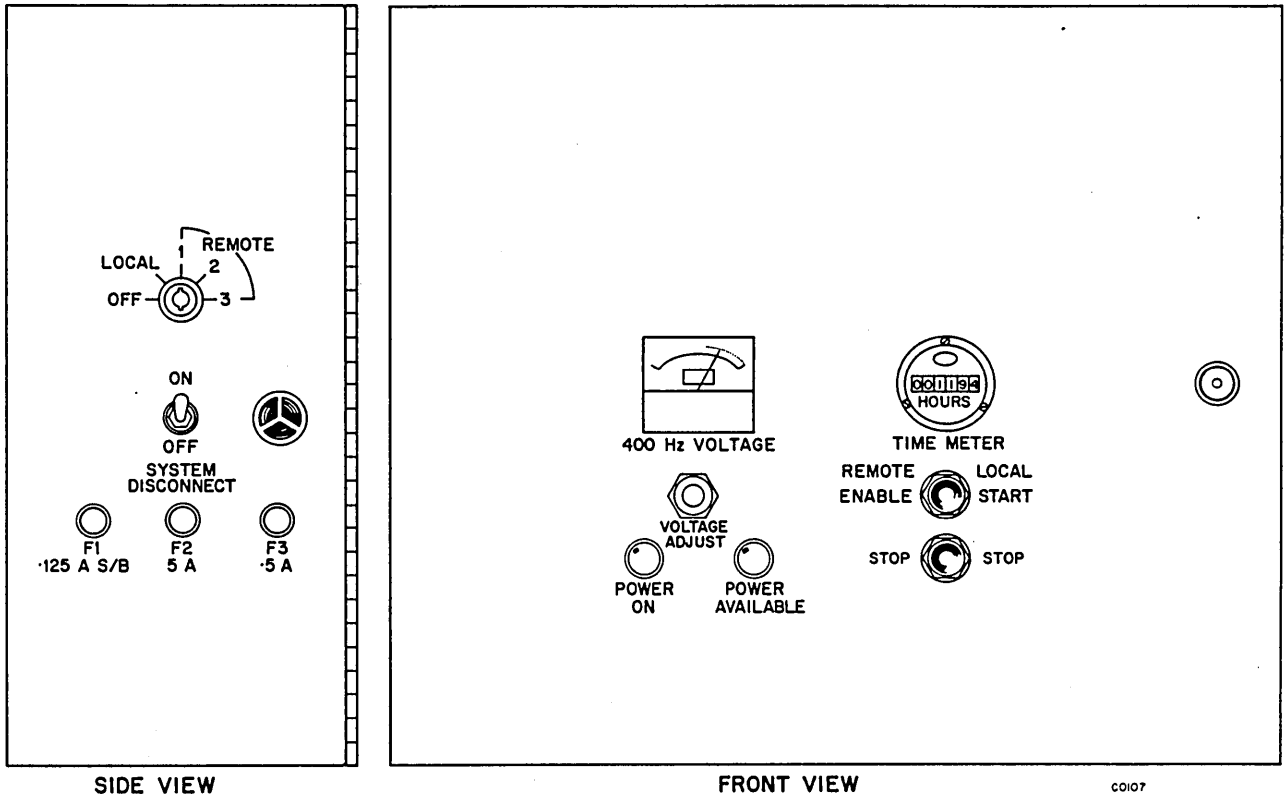

Figure 2-2. 400-Hz System Power Control Panel

TABLE 2-2. CABINET POWER CONTROL

Panel Marking/ Description	Function	Panel Marking/ Description	Function
OFF (Pushbutton Switch)	Disables the logic power supply DC outputs when pressed. The ON indicator and the power supply DC OUTPUT indicators turn off but the power supply HIGH V INPUT indicators stay on. The logic power supplies are preset to turn off sequentially. The off sequence can be different from the on sequence.	CONTROL, REMOTE/ LOCAL Toggle Switch	Determines whether logic power is controlled via the power control panel (LOCAL) or by a remote signal.
ON Indicator	Lights when the logic power supply DC outputs are successfully enabled when the ON switch is pressed, or when the AIR FLOW SENSOR TEST switch is pressed.	AIR FLOW SENSOR TEST Pushbutton Switch	Provides a test of the low air flow sensors. When pressed for two to three minutes continuously, the LOW AIR FLOW indicator and the FAULT indicator light if the sensors are functioning properly. The cabinet blower must be off during the test. If held on for an additional two minutes, the AC to DC converter input circuit breaker trips.
ON Pushbutton Switch	Enables the DC output of all of the logic power supplies if the circuit breakers are on, unregulated input voltage is present, NORMAL/DISABLE switches are set NORMAL, and no faults exist. The logic power supplies are preset to turn on sequentially. This sequence is shown by the lighting of the logic power supply DC OUTPUT indicators.		

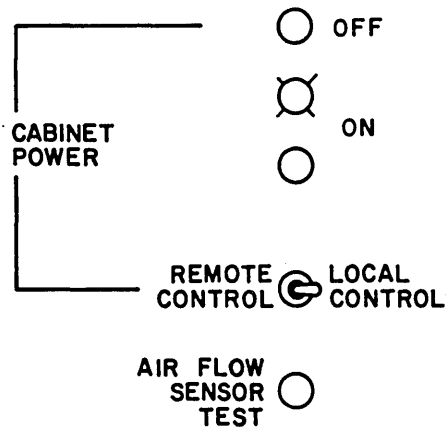

Figure 2-3. Cabinet Power Control

TABLE 2-3. BLOWER/CHARGER SWITCH AND CIRCUIT BREAKERS

Panel Marking/ Description	Function	Panel Marking/ Description	Function
BLOWER/CHARGER Toggle Switch	Allows battery charging and blower operation with the AC to DC CONVERTER INPUT circuit breaker off when down. It is up during normal operation.	50/60 HZ DISCONNECT Circuit Breaker	This is the 50/60 Hz AC main breaker. It is up during normal operation.
50/60 HZ CONTROL POWER Pushbutton Type Circuit Breaker	Protects the auxiliary bulk power supply. Push to reset.	AC TO DC CONVERTER INPUT Circuit Breaker	Protects AC to DC converter. It is up during normal operation. If it trips, the CB OFF system fault indicator lights. This can be a 50/60 Hz or 400 Hz breaker depending on system installation.
AUXILIARY POWER SUPPLY Toggle Type Circuit Breaker	Protects lines to the auxiliary power regulator. It is up during normal operation. If it trips or is not turned on, the CB OFF system fault indicator lights.	BATTERY DISCONNECT Toggle Type Circuit Breaker	Protects the battery circuit. When off (down), the CB OFF system fault indicator lights.
BLOWER/CHARGER POWER Toggle Type Circuit Breaker	Protects the blowers and charger. It is up during normal operation. If it trips or is not turned on, the CB OFF system fault indicator lights.		

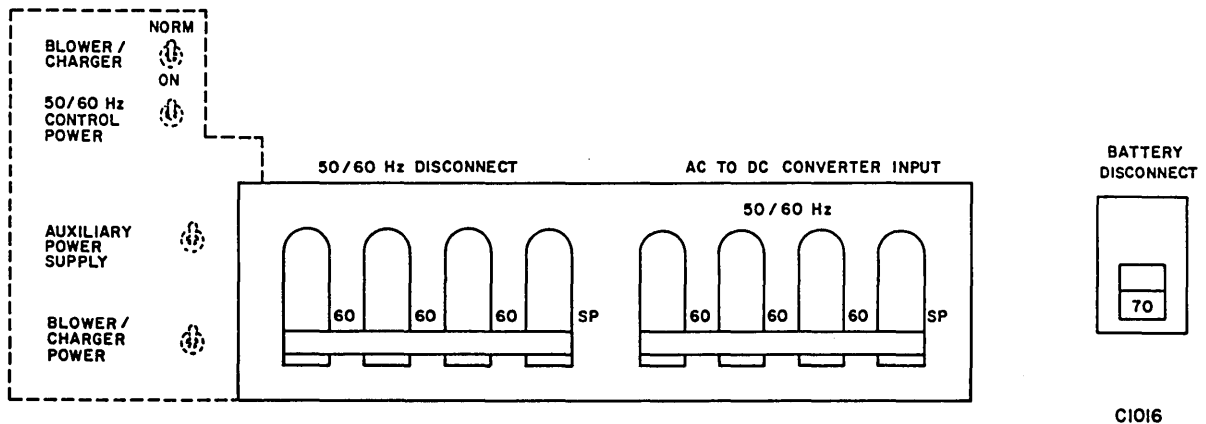
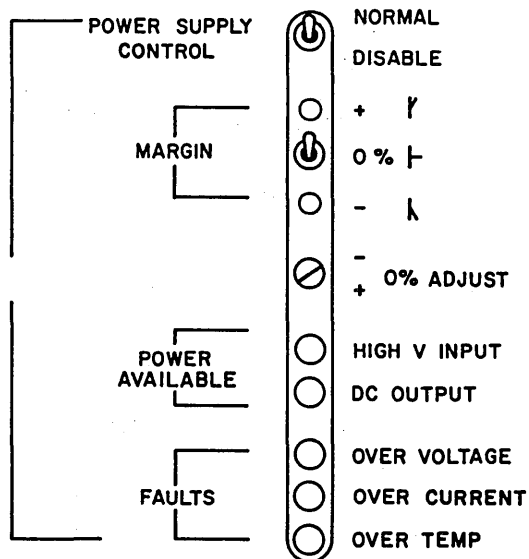

Figure 2-4. Blower/Charger Switch and Circuit Breakers

TABLE 2-4. LOGIC POWER SUPPLY CONTROLS

Panel Marking/ Description	Function	Panel Marking/ Description	Function
NORMAL/DISABLE Toggle Switch	In the NORMAL position, DC power appears at the output of the related power supply. In the DISABLE position, DC power is removed from the output of the related power supply, but the internal POWER GOOD signal is still generated. When all power supplies are in the DISABLE mode, the system POWER GOOD signal is disabled by the logic. Setting this switch to DISABLE and then back to NORMAL clears OVER VOLTAGE, OVER CURRENT, or OVER TEMP fault indication in the related power supply.	HIGH V INPUT Indicator	When on, indicates that voltage is present at the input of the related power supply, and that control/protection signals are present at the control connector of the related power supply.
MARGIN Toggle Switch	Allows +5% margin shift of the logic power supply output voltages. The MARGIN function can be performed using the terminal keyboard.	DC OUTPUT Indicator	When on, indicates that the voltage of the related power supply is within + 12 percent of nominal. The related power supplies turn on and off according to internal preset sequences (on and off sequences need not be identical).
+ MARGIN Indicator	Indicates a +5% margin shift.	OVER VOLTAGE Indicator	When on, indicates an over-voltage in the related power supply.
- MARGIN Indicator	Indicates a -5% margin shift.	OVER CURRENT Indicator	When on, indicates a problem in the related power supply's load, or within the power supply.
0% ADJUST Potentiometer	Allows adjustment of the power supply output voltage. Refer to Test Points under Voltmeter.	OVER TEMP Indicator	When on, indicates a cooling problem in the related power supply.
NOTE	When one or more of the voltage, current, or temperature indicators is on, the LOGIC POWER SUPPLY system fault indicator is on. Refer to System Fault Controls.		
	When the optional second CPU is not present, a jumper by-pass connector replaces the relevant logic power supply controls (CPU1 and MEM/IO).		



C1017

Figure 2-5. Logic Power Supply Controls

TABLE 2-5. VOLTMETER CONTROLS

Panel Marking/ Description	Function	Panel Marking/ Description	Function
ZERO ADJUST Potentiometers	When a power supply output is properly adjusted with a digital voltmeter, the related zero adjust potentiometer allows adjustment of the panel meter to 0%.	TEST POINTS, +VOLTS/-COMMON Test Jacks	Digital voltmeter probes connect to these points for checking and adjustment of the logic power supply DC outputs. The 0% ADJUST potentiometer on each logic power supply interface board adjusts the output to the correct voltage for that supply.
Rotary Switch	Switches the panel meter and test points to any one of the 8 logic power supply DC outputs.		

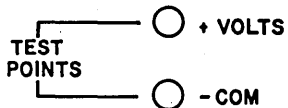
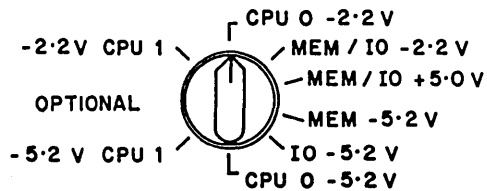
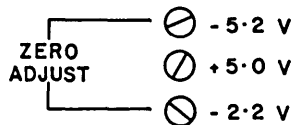
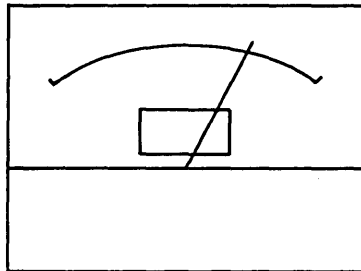

C1019

Figure 2-6. Voltmeter Controls

TABLE 2-6. SYSTEM FAULT CONTROLS

Panel Marking/ Description	Function
RESET Pushbutton Switch	Clears all fault conditions and enables power up. Press when PUSH RESET indicator is on.
CB OFF Indicator	When on, indicates that a circuit breaker other than the 50/60-Hz disconnect breaker or 50/60-Hz CONTROL POWER breaker has tripped or set to off.
CABLE PROTECTION Indicator	When on, indicates that a cable or connector is open (within the cable protect line).
LOGIC POWER SUPPLY Indicator	When on, indicates a fault in one of the logic power supplies.
SMOKE DET Indicator	When on, indicates a missing smoke detector bypass jumper on a protect board.
LOW AIR FLOW Indicator*)	When on, indicates low air flow in the power column or the logic columns.
PUSH RESET Indicator	Lights when any fault indicator lights. Depending on the fault, the lighting is immediate or after a time delay of 2 minutes or 2.5 seconds.
AIR OUT Indicator*)	Indicates high outlet temperature in a logic column or a missing bypass jumper in the power column protect board.
AIR IN Indicator*)	When on, indicates high ambient temperature in the power column or the logic columns.
FAULT Indicator (not shown)	When on, indicates an AIR FLOW, AIR IN fault, or a missing bypass jumper in the power column.
EMERGENCY OFF Toggle switch	When OFF, trips 50/60 Hz DISCONNECT, AC TO DC CONVERTER, and BATTERY DISCONNECT circuit breakers. Refer to section 6.

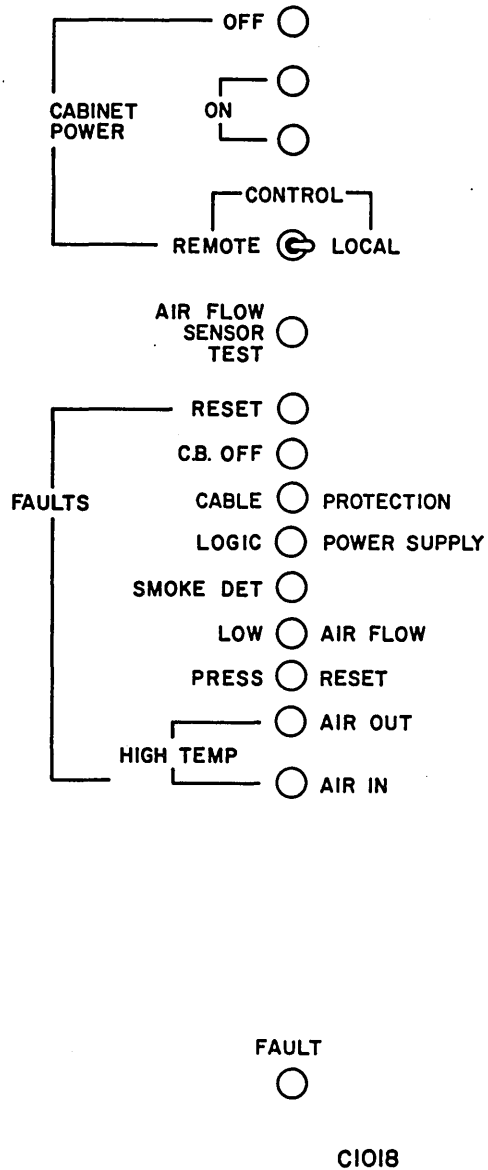

* To determine the logic column (1, 2 logic column) where the fault is detected, refer to the fault LED indicators at the back of the cabinet (figure 2-1).

Figure 2-7. System Fault Controls

TABLE 2-7. TWO PORT MUX BOX CONTROLS

Panel Marking/ Description	Function
PORT 0, 1 BAUD RATE SELECTION Rotary Switch	Selects baud rate of two port mux ports 0, 1 ranging from 110 to 19.2K.
PORT 0, 1 PORT OPTIONS Rotary Switch (keylock)	Selects port options of two port mux ports 0, 1. In DISABLED position, port is disabled. In MSG ONLY position, port is enabled, remote deadstart and remote power-up are disabled. In DS ENABLED position, port and remote deadstart are enabled, and remote power-up is disabled. In DS & PWR ENABLE position, port, remote deadstart, and remote power-up are enabled.
DIAGNOSTIC/NORMAL Toggle Switch	In NORMAL position, computer remains in normal operating mode. In DIAGNOSTIC position, sends a 4.096 millisecond pulse to microprocessor causing a non-mask interrupt for diagnostic purposes.

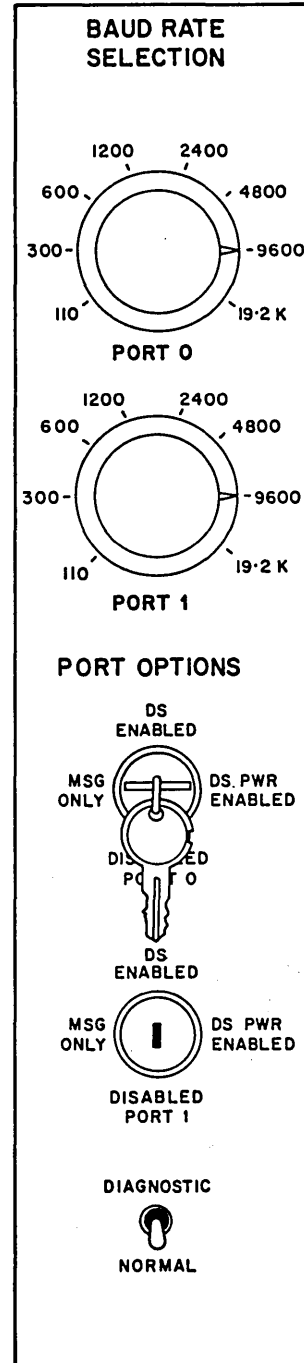

C1022

Figure 2-8. Two Port Mux Box

CENTRAL MEMORY CONTROLS

The CM contains five, 3-position configuration switch registers. In case of CM malfunctions, CM can be reconfigured through software commands to make it accessible by contiguous addresses from zero to the maximum remaining address. Set the configuration switch registers through deadstart display, described in section 3 of this guide.

With a switch centered, normal addressing takes place; with a switch up, the upper half of memory remains operational while the lower half becomes unavailable; with a switch down, the lower half remains operational while the upper half becomes unavailable.

The initial deadstart display shows only three configuration switches. Switches 3, 4, and 5 are shown when 64K memory chips are used; otherwise switches 1, 2, and 3 are shown. Table 2-8 defines address selections for each switch position.

TABLE 2-8. CM CONFIGURATION SWITCHES

Switch	Centered	Up	Down
SW1	-	-	-
SW2	Normal addressing	Use upper 2098K of 4186K*)	Use lower 2098K of 4196K*)
SW3	Normal addressing	Use upper 1049K of 2098K	Use lower 1049K of 2098K
SW4	Normal addressing	Use upper 524K of 1049K	Use lower 524K of 1049K
SW5	Normal addressing	Use upper 262K of 524K	Use lower 262K of 524K
*) 4196K is available for use in the virtual or dual state by NOS/VE.			

DISPLAY STATION CONTROLS

System options include two display stations, a 21-inch model and a tabletop model. The main parts of each display station are a display unit (with controls), and a keyboard.

DISPLAY UNITS

The display screen displays messages directed to it by the microcomputer, the operating system, or maintenance software, and messages entered on the console keyboard.

The microcomputer, operating system, and maintenance software library (MSL) use the display screen to bring information to your attention. You can alter and run the microcomputer programs, and respond to or instruct the operating system or maintenance software by entering information using the console keyboard.

DISPLAY CONTROLS

Figure 2-9 shows the display controls of the 21-inch model display station. The function of these controls is defined in table 2-9.

Figure 2-10 shows, and table 2-10 describes, the display controls of the tabletop model.

TABLE 2-9. DISPLAY STATION CONTROLS (21-INCH MODEL)

Panel Marking/ Description	Function	Panel Marking/ Description	Function
CENTERING HORIZ VERT Position controls	Varies horizontal and vertical position of display.	FOCUS Focus control	Changes clarity in center areas of display.
DEADSTART Deadstart pushbutton	Resets microprocessor and activates deadstart options display (figure 2-12).	INTENSITY Intensity control	Varies brightness of display.

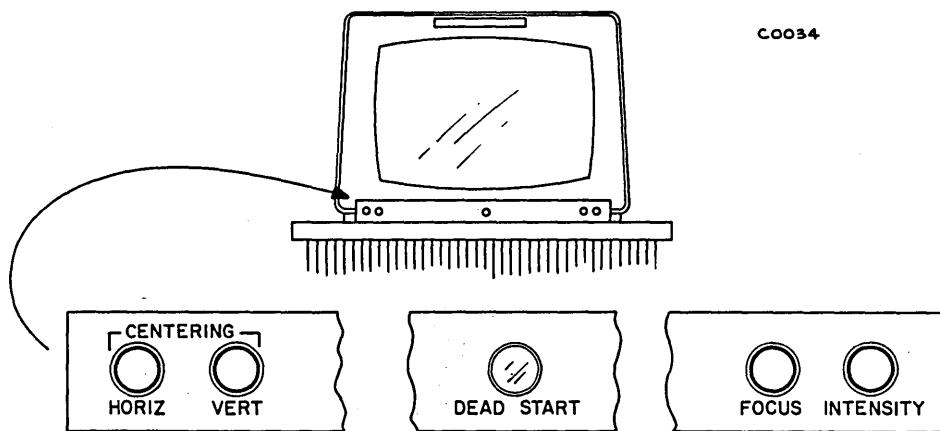
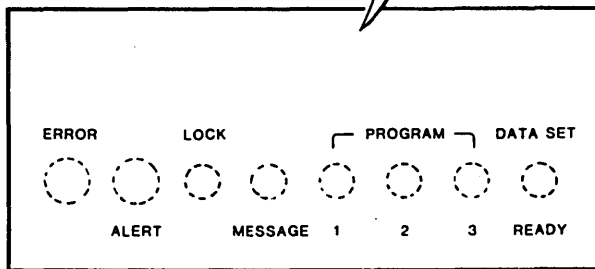
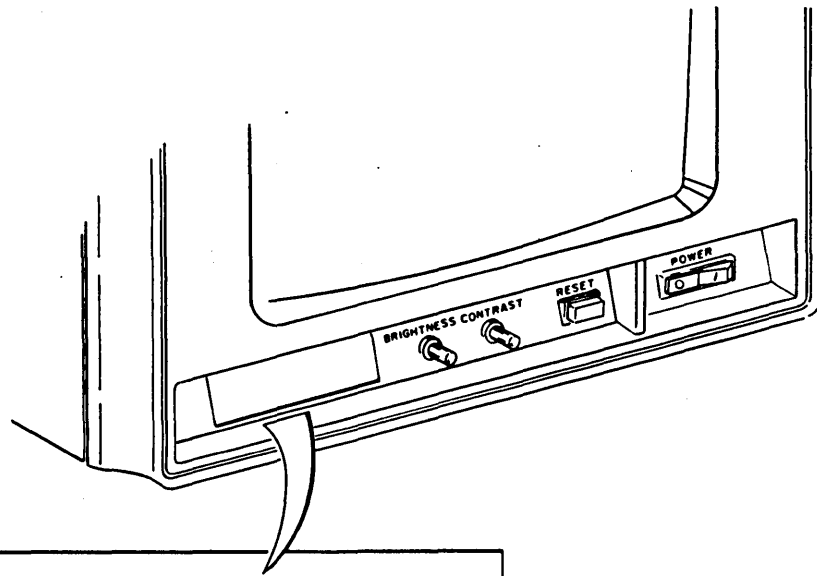
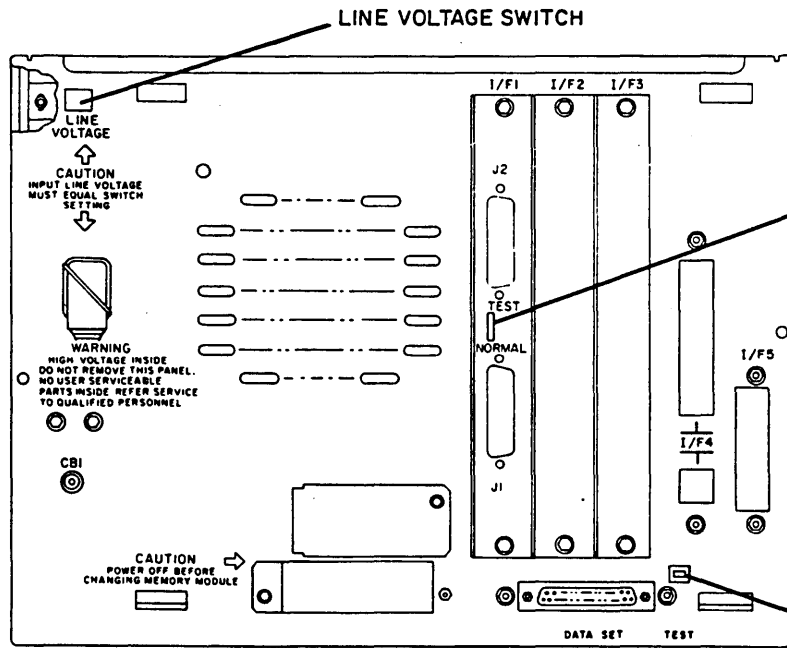

Figure 2-9. Display Station Controls (21-Inch Model)



FRONT VIEW



TEST SWITCH IF OPTION IS INSTALLED

REAR VIEW

TEST SWITCH

C1161

Figure 2-10. Tabletop Display Station

TABLE 2-10. DISPLAY CONTROLS (TABLETOP MODEL)

Panel Marking/ Description	Function	Panel Marking/ Description	Function
POWER 0/1 Switch	Turns primary power on/off.	MESSAGE (Message Waiting) Indicator	This indicator is under program control.
CB1 Circuit Breaker	Overcurrent protection.	ALERT Indicator	An alternate visible alert under program control, for use when the audible alarm is disabled or cannot be heard.
TEST Switch	When pulled out, performs maintenance loopback of the resident host interface (RS-232-C) and keyboard I/F for fault isolation.	ERROR Indicator	Illuminates under program control, when a terminal subsystem or mode dependent error condition is detected.
RESET Switch	Resets the terminal to a normal restart condition. Terminal activity is program dependent.	PROGRAM 1/ PROGRAM 2/ PROGRAM 3 Indicators	Under program control indicates conditions defined by the program.
BRIGHTNESS (Intensity) Control	Adjusts the video intensity.	AUDIBLE ALARM	A two-level (loud/soft) audible alarm under program control. The alarm occurs as follows: <ul style="list-style-type: none"> - After power on or RESET has run test 1. - After improper key depression during MODE selection. - Host code sequence. - During entry attempts when cursor is in protected position. - During entry attempts when keyboard is locked. - When margin alert is enabled and entry into the 8th position from end of line or into the last line takes place.
CONTRAST Control	Adjusts the intensity variation between characters and background.		
LINE VOLTAGE Switch	Selects line voltage range (115/220 v ac).		
<div style="border: 1px dashed black; padding: 2px; display: inline-block;">CAUTION</div> <p>This switch must be set to equal line voltage.</p>			
M-REL (Manual Release)	Initiates terminal microcode sequence which releases terminal. Any host operation is aborted.		
DATA SET READY Indicator	Illuminates when Data Set Ready signal at the modem (host) interface is present.		
LOCK Indicator	Illuminates when keyboard is locked. This happens during a page print operation, when the terminal is unable to transmit data due to loss of modem control signals, or when the terminal is disabled by host command. Also occurs during block mode communication with host, or when a disk operation is active.		

KEYBOARD

Figure 2-11 shows the keyboard of the 21-inch model display station. The PRESENTATION switch (to the right of the spacebar) allows selection of three different screen displays:

- LEFT selects A (left screen) display.
- RIGHT selects B (right screen) display.
- Middle position selects both A and B displays (left and right screens) reduced in size on a split screen.

Figure 2-12 shows the standard keyboard of the tabletop model. Model CC634B does not have a presentation switch.

KEYBOARD FUNCTIONS

With the operating system loaded, the keyboard functions as described in the operating system operator's guide. With the MSL loaded and the CMSE in control, the keyboard functions as shown in tables 2-11 and 2-12.

The following statements apply to 21-inch model keyboard entries during deadstart:

- Entries from the console keyboard appear on the bottom of the left screen as they are entered.
- The BKSP key deletes the previous character typed.
- The left blank key deletes the current line being typed (left blank is third key from right on top row of keyboard).
- The following message may appear above the console entry if the entry is unrecognizable to the system:

INVALID ENTRY

TABLETOP MODEL KEYBOARD FUNCTIONS

With the operating system loaded, the keyboard functions as described in the operating system operator's guide. (Not all operating systems support the tabletop model). With the MSL loaded and the CMSE in control, the keyboard functions are described in table 2-12.

TABLE 2-11. 21-INCH MODEL CMSE KEYBOARD FUNCTIONS

Key	Function	Key	Function
Erase (blank key to left of =)	Clear keyboard line.	Minus (-)	Decrement base address, index, or ordinal associated with current A (left screen) display.
Equals (=)	Switch B (right screen) display from test display to memory display or vice versa.	Right parenthesis ()	Decrement base address, index, or ordinal associated with B display (right screen).
Backspace (BKSP) (blank key above CR)	Delete last character entered.	Forward (blank key to right of =)	Execute command, increment address parameter, and clear data parameter. If data entry is repeated without entering data, no data is stored.
Comma, period, or space	Accepted as command separator.	Carriage return (CR)	Execute command entered. Initial entry of CR causes single byte of zeros for test command.
Plus (+)	Increment base address, index, or ordinal associated with current A (left screen) display.	Consecutive commas	When used in command entry, zeros are entered for parameter not entered.
Left parenthesis ((Increment base address, index, or ordinal associated with B display (right screen).		

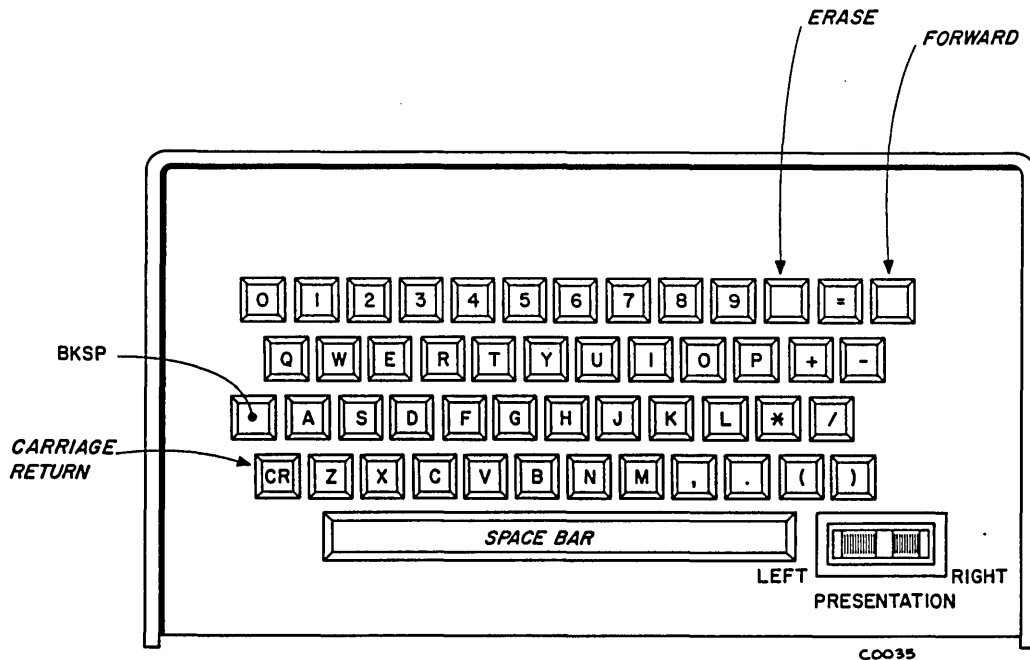

Figure 2-11. 21-Inch Keyboard

TABLE 2-12. TABLETOP MODEL CMSE KEYBOARD FUNCTIONS

Key	Function	Key	Function
ESC or ERASE	Clear keyboard line.	Comma, period, or space	Accepted as a command separator.
Equal (=) or F3	Switch from a test display to a memory display or vice versa.	Consecutive commas	When used in a command entry, zeros are entered for the parameter not entered.
Left arrow () or CNTR and H	Delete last character entered.	Slash (/)	Substitute the last automatically assigned PP number.
Plus (+), left parenthesis (), or DOWN	Increment the base address, index, or ordinal associated with the current display.	Dollar sign (\$)	Select CH/PP display.
Minus (-), right parenthesis (), or UP	Decrement the base address, index, or ordinal associated with the current display.	Pound sign (#)	Select other half of current display.
Percent (%) or FWD	Execute the command, increment the address parameter, and clear the data parameter. If a data entry is repeated without entering data, no data is stored.	CTRL and I	Initialize terminal. Manually establish operating characteristics of the console. Used whenever the terminal parameters appear to have been damaged.
Carriage return (CR) or NEXT	Execute the command entered. An initial entry of (CR) causes a single byte of zeros for a test command.	F4 or HELP	Introduce information displays and how to access the displays. See HELP display under the description of the Display Help Information (AI, BI) command later in this section.

CSME supports the following characters: (/ - =
A through Z) , # \$
a through z (displayed as A through Z) + . #
0 through 9

Except as noted above, function keys on the CC634B console are not supported. On the CC634B console an alarm (beep) sounds when a key other than those shown in this table is pressed.

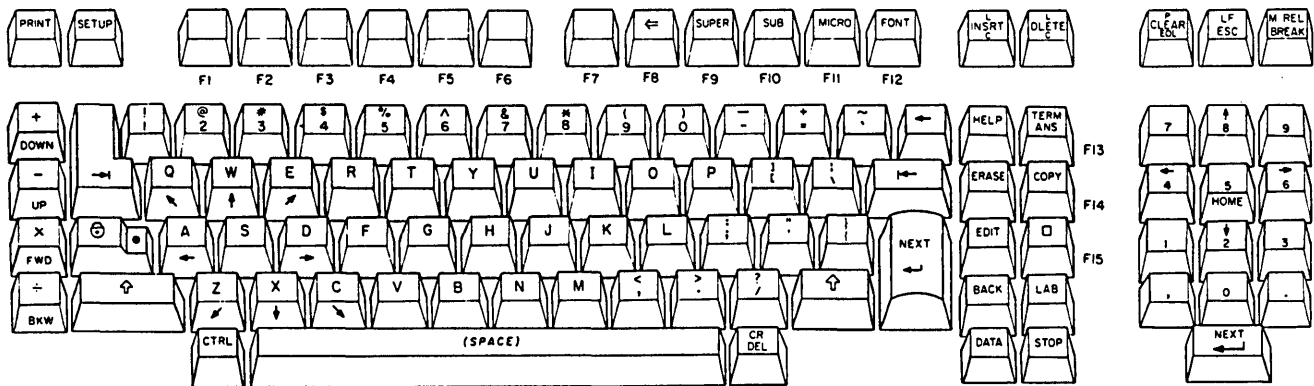

C1162

Figure 2-12. Tabletop Keyboard

DEADSTART OPTIONS DISPLAY

The first display after a reset procedure 4-3 is the deadstart options display (figure 2-13). It gives the operator an S option (system load options) and an M option (maintenance options). The S option is described in CIP User's Handbook. The M option calls up the initial deadstart display which provides operator controls through system software (figure 3-1).

```
DEADSTART OPTIONS

S SYSTEM LOAD OPTIONS
M MAINTENANCE OPTIONS

(CR) - SYSTEM LOAD OPTIONS

PROGRAM n SELECTED
```

Figure 2-13. Deadstart Options Display

INITIAL DEADSTART DISPLAY

You may use the initial deadstart controls to do the following:

- Select a 16-word deadstart program for PPO.
- Initiate the deadstart sequence for PPO to reconfigure PPMs/barrels and CM.
- Display error status and maintenance information.

The initial deadstart display (figure 3-1) contains the following information:

- 16-word deadstart program for PPO. Program words are numbered sequentially from 1 through 20g; each word comprises six octal digits.
- List of some basic commands (xx yyyyyy, xx+yyyyyy, S, L, and H).
- Reconfiguration status for PPMs and barrels.
 - The line PPM CONF=xx indicates current reconfiguration status of PP memories. The number xx is an octal number in the range 0 through 11, and is the number of the physical PP memory being used as logical PPO.
 - Similarly, the line BRL CONF=x, where x is 0 or 1, indicates which physical barrel is being used as logical barrel 0.
- Reconfiguration status for CM. The line CM RECONF SW3=C, SW4=U, SW5=D indicates status of CM reconfiguration switch registers (C=center, U=up, D=down).

For reconfiguration directions and commands see section 3 of this guide.

- Keyboard entry line. The bottom line displays operator entries.
- Error line. The message ERROR on the line immediately above the keyboard entry line indicates an error in the keyboard entry.
- LDS status. If a long deadstart sequence (LDS) aborts because of a hardware malfunction, the lower right-hand side of screen displays the type of error. These errors are:
 - LDS BRANCH TEST FAILURE
 - LDS DATA/ADDRESS ERROR
 - STATUS SUMMARY ERROR (for IOU errors only)
- PP registers. The P, A, Q, and K registers for PPs 0 through 11 may be displayed on the right-hand side of the screen. This display is brought up automatically during long deadstart; it can be brought up manually by the maintenance command PR.

Other displays and commands are available for maintenance and for software debugging. Refer to CIP User's Handbook.

DEADSTART PROGRAMS

Activating the initial deadstart display causes the last previously displayed deadstart program to be redisplayed on the screen; if none is available, hardware generates one which consists of a jump to itself followed by all zero instructions.

Subsequently, a deadstart command (L or S) invokes a deadstart sequence which loads the 16-word program currently displayed on the console into locations 1 through 20g of PPO, and starts execution of the program at location 1. Commands are provided to enter or modify this program; therefore, it is not necessarily a copy of any of the programs 0 through 7 stored in microprocessor memory.

Multiple programs may be created for different uses (coldstart, warmstart etc.) and may be saved in a special memory as described in section 4 of this guide. Up to four such programs may be stored with the command SP x where x is the program number (x=0-3). Once a program has been stored, it may be retrieved at a later time with the command GP x where x is the program number to be retrieved.

In addition to the four programs that may be stored with the SP command, four more fixed programs can be accessed using the GP command. These programs are numbered 4 through 7. Hence, allowable values of the parameter x are 0 through 7 (programs 4 through 7 are intended for maintenance use).

After a GP command, the program number, x, is displayed on the screen for reference only.

The next higher numbered program may be displayed by pressing the space bar on the keyboard. The program displayed after pressing the deadstart pushbutton and then letter M is the last program that was previously selected.

If any editing of the program is done, only the local or screen version is changed. The original version in location x is not modified. Stored programs are changed only by a SP x command; therefore, it is possible to get a program from one location, perform editing, and save it in a different location.

EDITING PROGRAMS

Two commands are provided to edit a program displayed on the screen:

xx yyyyyy (or xx.yyyyyy, or xx,yyyyyy)

Changes the single word (xx) in the program to a new value (yyyyyy). The number xx may be any octal number in the range 1 through 20. The number yyyyyy may be any string of up to 6 octal digits in the range 0 through 177777. Leading zeros do not have to be typed for xx or yyyyyy.

xx+yyyyyy

Changes a block of sequential words in the program. As each new word is entered, the editor program automatically increments the value xx and clears the remainder of the line so that the value at the (incremented) address may be entered. The sequence is terminated automatically when word number 20 has been entered. It can also be terminated at any point with the erase key (left blank key on top row of keyboard).

BATTERY

The CK PAK in IOU incorporates a non-rechargeable lithium battery capable of powering the micro-processor circuits for 3000 hours during power failures, and with a shelf life of 11 years. This battery maintains the contents of deadstart programs 0 through 3, the reconfiguration status, and the time of day when line power is removed. Should this battery become discharged, the loss of data is sensed and the following action is taken when the battery is replaced:

- Deadstart programs 0 through 3 are erased and replaced with a 000300 in word 1 and zeros in all remaining words.
- The time of day is erased, and a status bit is set for software to indicate a loss of time data.
- When the M deadstart display is activated, the following warning message is displayed.

BAT FAIL:RE-ENTER ALL DS PROG

This message disappears when the first entry is typed into the deadstart program on the screen.

DEADSTARTING THE PPs

From the initial deadstart display, two basic commands deadstart the PPs:

S Followed by CR initiates a short deadstart sequence. In this sequence, a Master Clear is issued to the PPs and the program currently displayed on the screen is loaded into logical PPO. Execution begins at word 1 of this program. The program used is the one displayed on the screen, not the permanently stored program from which it was derived using GP x and editing (see Deadstart Programs in this section). At the end of this sequence, the screen of the display station is blanked in preparation for use by the software which is being deadstarted in PPO.

L Followed by CR initiates a long deadstart sequence. In this sequence, the following events occur:

- Master Clear is issued to the PPs, and all error status bits are cleared.
- A fixed test program (stored in ROM) is executed in logical PPO.
- The PP register display is brought up on the right-hand side of the screen while the long deadstart program is running (runs for about 15 seconds).
- Certain error status bits are monitored to determine if the hardware failed during long deadstart. In case of failure, one of the messages listed previously will be displayed below the PP register display.
- If the program runs to completion without error, a short deadstart sequence is automatically initiated using the program currently displayed on the screen.

HELP

The command H followed by CR calls up the HELP display. This display provides a complete list of commands that may be used to change deadstart programs or invoke maintenance displays. The HELP display is removed by entering any command which brings up another display.

CAUTION

Maintenance commands and displays should not be used by the operator unless the customer engineer (CE) requests them.

SECTION 3

INITIAL ADJUSTMENTS

TABLE 3-1. DEADSTART PROGRAMS FOR COLDSTART

834 ISD Subsystem		
Word	Octal Setting	PP Mnemonic
01	75cc	DCN
02	77cc	FNC
03	01md	FNC
04	0300	(parms)

cc ISD subsystem channel number
m Control module (0 through 7)
d Unit number of disk (0 through 3)
parms Parameters

7152 Controller from Disk					
Active Channel			Inactive Channel		
Word	Octal Setting	PP Mnemonic	Word	Octal Setting	PP Mnemonic
01	1402	LDN	01	75cc	DCN
02	73cc	OAM	02	77cc	FNC
03	0007	(fwa)	03	01uu	(fnc)
04	75cc	DCN	04	0300	(hang)
05	77cc	FNC	05	0000	(zeros)
06	01uu		06	0000	(zeros)
07	0000	(zeros)	07	0000	(zeros)
10	0300	(hang)	10	0000	(zeros)
11	0000	(zeros)	11	0000	(zeros)
12	0000	(zeros)	12	0000	(zeros)
13	0000	(zeros)	13	0000	(zeros)
14	0000	(zeros)	14	0000	(zeros)
15	0000	(zeros)	15	0000	(zeros)
16	0000	(zeros)	16	0000	(zeros)
17	0000	(zeros)	17	0000	(zeros)
20	0000	(zeros)	20	0000	(zeros)

7152 Controller from Tape					
Active Channel			Inactive Channel		
Word	Octal Setting	PP Mnemonic	Word	Octal Setting	PP Mnemonic
01	1402	LDN	01	75cc+	DCN
02	73cc	OAM	02	1701	(delay
03	0013	(fwa)	03	0576	loop)
04	75cc	DCN	04	2400++	(pass)
05	1701	(delay	05	2300++	(pass)
06	0576	loop)	06	77cc	FNC
07	2400+	(pass)	07	007u	
10	2400+	(pass)	10	0300	(hang)
11	77cc	FNC	11	0000	(zeros)
12	007u		12	0000	(zeros)
13	0000	(zeros)	13	0000	(zeros)
14	0300	(hang)	14	0000	(zeros)
15	0000	(zeros)	15	0000	(zeros)
16	0000	(zeros)	16	0000	(zeros)
17	0000	(zeros)	17	0000	(zeros)
20	0000	(zeros)	20	0000	(zeros)

Code	Description
cc	Active (assigned) 844 channel number (1, 3, 4, 6, 7, 11, 20, 21, 23, 24, 26, 27, 31) Inactive (unassigned) 844 channel number (0, 12, 32, or 33).
u	Second octal digit of 844 disk drive unit number (00-03) with prerecorded peripheral microcode pack.

Code	Description
cc	Active (assigned) MTC channel number (1, 3, 4, 6, 7, 11, 20, 21, 23, 24, 26, 27, 31) Inactive (unassigned) MTC channel number (0, 12, 13, 32, or 33).
u	Second octal digit of tape drive unit number (00-17g).
fwa	First word address.

63X ISMT Subsystem					
Active Channel			Inactive Channel		
Word	Octal Setting	PP Mnemonic	Word	Octal Setting	PP Mnemonic
01	1402	LDN	01	0000	PSN
02	73cc	OAM	02	0000	PSN
03	0017	(fwa)	03	0000	PSN
04	75cc	DCN	04	75cc	DCN
05	77cc	FNC	05	77cc	FNC
06	060u	(fnc)	06	060u	(fnc)
07	1500	LCN	07	1500	LCN
10	3430+	STD	10	3430	STD
11	77cc	FNC	11	77cc	FNC
12	0012	(fnc)	12	0012	(fnc)
13	74cc	ACN	13	74cc	ACN
14	71cc	IAM	14	71cc	IAM
15	0030	(fwa)	15	0030	(fwa)
16	0300	UJN	16	0300	UJN
17	0000	(zeros)	17	0000	(zeros)
20	7112	IAM	20	7112	IAM

Code	Description
cc	Channel number.
fwa	First word address.
fnc	Function code.
u	Tape unit number (0 through 3).

+ If the channel cc equals zero, this instruction must be 7540.
++ If a 6681 or 6684 DCC or a CYBER 180 DCC is on the channel, these two instructions should be:
77cc Deselect DCC.
2100

TABLE 3-2. DEADSTART PROGRAM FOR WARMSTART

Active PP 1, 3, 4, 6, 7, 11			Inactive PP (Channel 0, 12g)		
Word	Octal Setting	PP Mnemonic	Word	Octal Setting	PP Mnemonic
01	1402	LDN	01	0000	PSN
02	73cc	OAM	02	0000 ¹	PSN
03	0017	(fwa)	03	0000 ¹	PSN
04	75cc	DCN	04	75cc ²	DCN
05	77cc	FNC	05	77cc	FNC
06	eddd	(fnc)	06	eddd	(fnc)
07	74cc	ACN	07	74cc	ACN
10	71cc	IAM	10	71cc	IAM
11	7301	(fwa)	11	7301	(fwa)
12	wxyf	(parms)	12	wxyf	(parms)
13	r0xx	(parms)	13	r0xx	(parms)
14	0000	(zeros)	14	0000	(parms)
15	0000	(zeros)	15	0000	(zeros)
16	0000	(zeros)	16	0000	(zeros)
17	0000	(zeros)	17	0000	(zeros)
20	7112	IAM	20	0000	(zeros)

Entry	Meaning
cc	Channel used to access deadstart equipment
fwa	First word address
fnc	Function
parms	Parameters
eddd	Selects deadstart device as follows: 63X = e12u 66X = e26u 67X = e12u 834 = 03cu (with self-checking diagnostics) 834 = 05cu (no self-checking diagnostics) 844 = e3uu 885 = e3uu e Controller to which deadstart unit (0 through 7) c Control module (0 through 7) u Unit on which deadstart tape or disk pack is mounted: = 0 through 1 (63 K)

Entry	Meaning
	= 0 through 7 (66X) = 0 through 17 (67X) = 0 through 3 (834) = 0 through 7 (844) = 40 through 57 (885)
wxyf	Defined for MSL/HIVS:
w	Size of UEM: 0 = none 3 = 5xxK 6 = 2M 1 = 1xxK 4 = 1M 7 = 2.5M 2 = 2xxK 5 = 1.5M
x	CM size: 0 = 16K 3 = 65K 6 = 198K 1 = 32K 4 = 98K 7 = 262K 2 = 49K 5 = 131K
y	CPU type: 1 = 810, 815, 825, or 830
f	If set when long deadstart is selected, rightmost bit of f selects EDS.
rpxx	r Indicates initialization or recovery level used by operating system and CTI/HIVS (see operating system operator's guide). xx Indicates the CMRDECK number (see operating system operator's guide).

- If a 6681 Data Channel Converter is first equipment on deadstart channel, set words 2 through 4 as follows:

02	75cc	DCN
03	77cc	FNC
04	2100	(fnc)
- Disconnect channel number (DCN) is 75cc; cc field must have the most significant bit set (cc = lxx xxx) where xxxxx represents the channel number in binary (0 through 31 decimal).

MAINFRAME RECONFIGURATION

When you have a hardware problem, you can reconfigure the mainframe hardware to continue operation. Two types of reconfiguration are possible:

- Mainframe hardware reconfiguration using the initial deadstart display PP and CM reconfiguration options.
- Reconfiguration of the operating system hardware using CTI options.

Refer to the CIP User's Handbook for operating system hardware reconfiguration procedures using CTI. The following paragraphs provide instructions for reconfiguring the PPs and for decreasing the amount of CM available using switches.

PP RECONFIGURATION

The system associates a number with each PP. For a given hardware configuration, this numbering is always the same and is called the logical PP number. Logical PP numbers appear at the top of the MSL left screen (A display). Refer to the appropriate operating system operator's guide for descriptions of other displays which identify logical PP numbers.

Reconfiguring the hardware causes a change in the logical PP number assignment. When the computer system is fully operational, logical PPO is associated with physical PP memory. You can reconfigure the PPs by assigning a different physical PP to logical PPO using the reconfiguration options on the deadstart display.

Within the hardware, PPs are assembled into groups of ten, called barrels. Depending on the number of PPs in your system, you can have one or two barrels, numbered 0 and 1. PPs are numbered in octal: 0 through 11, and 20 through 31.

In order to deadstart operating system, logical PPs 0, 1, 2, and 10g must be functional. The system can then be deadstarted and other (failing) PPs can be logically turned off using the CTI commands described in the CIP User's Handbook. If one of the required PPs is not functional, reconfigure the hardware so that logical PPs 0, 1, 2, and 10g are good, as described below.

Hardware reconfiguration of PPs is accomplished by a combination of reconfiguring barrels and PP memories. Barrels can be reconfigured only if the system contains 20 PPs.

To reconfigure barrels use the deadstart display and enter the command RB x where x is the number of the barrel (0 or 1) to be used as logical barrel 0 (contains logical PPO). The value x appears on the line BRL CONF=x. The other barrel becomes logical barrel 1 and contains logical PP20.

To reconfigure PP memories within each barrel, use the deadstart display and enter the command RP xx where xx is the number of the physical PPM to be used for logical PPO (valid numbers for xx are described below). The value xx then appears on the line PPM CONF=xx. Setting the value xx not only designates which PP in logical barrel 0 is to be PPO, but also designates which PP in logical barrel 1 is to be logical PP20, with the remaining PPs being renumbered circularly within each barrel.

Reconfiguration options for 10 and 20 PP systems (figure 3-2) are described below.

Reconfiguring 10-PP Systems

A 10-PP configuration has only one barrel, containing PPs 0 through 11g. The only means of reconfiguration is to use the RP xx command. The parameter xx may be any octal number in the range 0 through 11g. Selection of a value greater than 11g, nonoctal numbers (8, 9) or use of the RB command are rejected and result in the error message ERROR.

No. of PPs	Physical PPMs in Each Barrel	Logical PP Numbers				Comments
		RB=0		RB=1		
		BAR0	BAR1	BAR0	BAR1	
10	00	00				0 ≤ RP ≤ 11 valid RB not valid
	01	01				
	02	02				
	03	03				
	04	04	X	X	X	
	05	05				
	06	06				
	07	07				
	10	10				
	11	11				
20	00	00	20	20	00	0 ≤ RP ≤ 11 valid RB valid
	01	01	21	21	01	
	02	02	22	22	02	
	03	03	23	23	03	
	04	04	24	24	04	
	05	05	25	25	05	
	06	06	26	26	06	
	07	07	27	27	07	
	10	10	30	30	10	
	11	11	31	31	11	

RP = PP Reconfiguration
RB = Barrel Reconfiguration

Figure 3-2. PP Reconfiguration RP=0

No. of PPs	Physical PPMs in Each Barrel	Logical PP Numbers				Comments		
		RB=0		RB=1				
		BAR0	BAR1	BAR0	BAR1			
10	00	07				0 ≤ RP ≤ 11 valid RB not valid		
	01	10						
	02	11						
	03	00						
	04	01	X	X	X			
	05	02						
	06	03						
	07	04						
	10	05						
	11	06						
	20	00	07	27	27		07	0 ≤ RP ≤ 11 valid RB valid
		01	10	30	30		10	
02		11	31	31	11			
03		00	20	20	00			
04		01	21	21	01			
05		02	22	22	02			
06		03	23	23	03			
07		04	24	24	04			
10		05	25	25	05			
11		06	26	26	06			

RP = PP Reconfiguration
RB = Barrel Reconfiguration

Figure 3-3. PP Reconfiguration RP=3

Reconfiguring 20-PP Systems

A 20-PP system has two barrels. Barrel 0 contains physical PPs 0 through 11g and barrel 1 contains physical PPs 20g through 31g. Reconfiguring the barrels using the RB x command results in interchanging physical PPs 0 through 11g and 20g through 31g (figures 3-2 and 3-3). The RP xx command then rennumbers PPs within their logical barrels. Both barrels are reconfigured, with the value xx specifying which PP in logical barrel 0 is to be used as logical PPO and which PP in logical barrel 1 is to be used as logical PP20g. The parameter xx may be any octal number in the range 0 through 11g. Values greater than 11g or nonoctal numbers (8, 9) are rejected and result in the message ERROR.

PROCEDURE 3-1. RECONFIGURE PPs

1. Activate deadstart and press M. Initial deadstart display appears as shown in figure 3-1.
2. Locate Reconfiguration Parameter on deadstart display and determine its value. If either parameter is nonzero, the PPs have probably been reconfigured; additional reconfiguration is not recommended. If both parameters are 0, proceed to step 3.
3. Enter command RB 0 or RB 1 and press CR to select barrel 0 or 1 respectively as barrel to contain logical PPO.
4. Enter command RP xx where xx is an octal number from 0 to 11 to select which PP within barrel is to be logical PPO, then press CR. Use figures 3-2 and 3-3 to select appropriate reconfiguration parameters.

TABLE 3-3. CM RECONFIGURATION

CM Size Words	Failing Address Range	Configuration Switches			CM after Reconfig. Words
		SW3	SW4	SW5	
2000K	000000 - 0FFFFF	U	C	C	1000K
2000K	100000 - 1FFFFF	D	C	C	1000K
1000K	600000 - 07FFFF	C	U	C	500K
1000K	080000 - 0FFFFF	C	D	C	500K
500K	000000 - 03FFFF	C	C	U	250K
500K	04FFFF - 07FFFF	C	C	D	250K
		SW1	SW2	SW3	
4000K	000000 - 1FFFFF	C	U	C	2000K
4000K	200000 - 3FFFFF	C	D	C	2000K
2000K	000000 - 0FFFFF	C	C	U	1000K
2000K	100000 - 1FFFFF	C	C	D	1000K

*) 4000K is available for use in the virtual or dual state by NOS/VE.

PROCEDURE 3-2. RECONFIGURE CENTRAL MEMORY

1. Activate deadstart and press M. Initial deadstart display appears on screen as shown in figure 3-1.
2. Locate normal size of CM from CM size column from table 3-3.
3. Locate correct line within grouping by selecting range of addresses which include the defective portion of memory.
4. Determine configuration switch settings. Normally, all switches are centered. If CM has been reconfigured or degraded once, one switch is up or down. If CM has been reconfigured or degraded twice, two or more switches are up or down; additional reconfiguration is not recommended.
5. For memories implemented with 64K memory chips, enter command SWx y where x is 3, 4 or 5; and y is C for center, U for up, or D for down. Press CR.

For memories implemented with 256K chips, do the same except enter x as 1, 2, or 3.

CENTRAL MEMORY RECONFIGURATION

CM reconfiguration permits you to restructure the CM addresses so a failing part of CM can be locked out quickly to provide a continuous block of usable CM. CM is reconfigured by three configuration switch registers accessible through the deadstart display. Each switch has three positions: up, centered, and down. When all switches are centered, the entire installed physical CM is available for use. Switches set to either the up or down position degrade real memory as shown in table 3-3. In this table, the D, U, and C indicate switch positions down, up, and centered, respectively.

Memory reconfiguration should be viewed only as a stop-gap measure; it is a way to keep the system operational until a CE arrives to correct the problem. For this reason, degrading memory more than twice is not practical. To reconfigure CM, use procedure 3-2.

SECTION 4

STARTUP PROCEDURES

This section provides procedures for applying power to the computer mainframe and for performing deadstart operations. Deadstart is the process that makes the operating system or maintenance software operational and ready to process jobs or run tests.

POWER APPLICATION PROCEDURES

Power application procedures depend upon whether power application is under local or remote control. They are for normal conditions, initial startup, and power outage recovery (procedures 4-1 through 4-5).

PROCEDURE 4-1. POWER APPLICATION, INITIAL STARTUP OR RECOVERY

Follow the steps below before continuing with procedures described in procedure 4-2, under local control (SPCP) or local control (NO SPCP), whichever applies.

1. Set EMERGENCY OFF switch to ON (up).
2. Set BLOWER/CHARGER toggle switch to NORMAL.
3. Set BLOWER/CHARGER circuit breaker to ON.
4. Press the 50/60 HZ CONTROL POWER breaker button.
5. Set AUXILIARY POWER SUPPLY breaker to ON.
6. Set 50/60 HZ DISCONNECT breaker to ON.
7. Set AC TO DC CONVERTER INPUT breaker to ON.
8. Set BATTERY DISCONNECT breaker to ON (if applicable).
9. Press fault RESET.
10. Set all logic power supply NORMAL/DISABLE switches to NORMAL.

PROCEDURE 4-2. POWER APPLICATION, NORMAL CONDITION

Select the procedure that suits your system from the five below.

- Local control (No SPCP)
- Local control (SPCP)
- SPCP control
- Remote control (SPCP)

An SPCP is required with a 25-kVA MG system.

LOCAL CONTROL (NO SPCP)

1. Do procedure 4-1.
2. Press CABINET POWER ON push button.

LOCAL CONTROL (SPCP)

1. Set mode switch on side of SPCP to LOCAL.
2. Do procedure 4-1.
3. Press CABINET POWER ON pushbutton.

SPCP CONTROL

1. Do procedure 4-1.
2. Set LOCAL/REMOTE toggle switch on mainframe power control panel to REMOTE.
3. Set SPCP SYSTEM DISCONNECT toggle switch to ON. The POWER AVAILABLE LED lights.
4. Set SPCP MODE keyswitch to LOCAL.
5. Press SPCP REMOTE ENABLE/LOCAL START switch. The system powers on.

REMOTE CONTROL (SPCP)

1. Do procedure 4-1.
2. Set LOCAL/REMOTE toggle switch on mainframe control panel to REMOTE.
3. Set SPCP SYSTEM DISCONNECT toggle switch to ON.
4. Set SPCP MODE keyswitch to REMOTE 1.
5. Press SPCP REMOTE ENABLE/LOCAL START switch. The system will now respond to software commands.

DEADSTART PROCEDURES

There are two types of deadstart procedures, called warmstart and coldstart. The warmstart procedure (procedure 4-1) assumes that the necessary peripheral microcode has already been loaded into the tape or disk controllers which are to be used for the deadstart operation. The coldstart procedure (procedure 4-1) loads the peripheral microcode into the tape or disk controllers before performing the deadstart sequence. In general, after power has been off on a controller, a coldstart is required.

The power-on initialization procedure adds steps which ensure the mainframe memories are initialized properly after application of power to the system.

NOTE

After a tabletop model (721) display station is installed, it must be initialized as described in Model 810, 810A, 65810, 830, 830A and 65830 Installation and Checkout Manual.

PROCEDURE 4-3. RESET TO INITIAL DEADSTART DISPLAY

To activate the initial deadstart display from the 21-inch model display station, do the following:

1. Press DEADSTART button on display unit control panel. Deadstart options display appears.
2. Enter letter M. Initial deadstart display appears.

To activate the initial deadstart display from the tabletop model display station, do the following:

1. Press RESET button on display unit control panel.
2. Press and hold CTRL, then press G. Message OPERATOR ACCESS ENABLED appears.
3. Press and hold CTRL, then press R. Deadstart options display appears.
4. Press M. Initial deadstart display appears.

PROCEDURE 4-4. ENTERING A DEADSTART PROGRAM

1. If the required deadstart program is already stored in microprocessor RAM, retrieve this program by typing GP n followed by a carriage return; n is the RAM program number (0 through 3 octal).
2. If the required deadstart program is not in microprocessor RAM, enter this program from table 3-1 using the console keyboard. Program entry is done by typing xx yyyyyy followed by a carriage return. The location is xx (1 through 20 octal) and the instruction is yyyyyy (octal).

The first two digits of the instruction should be zeros; however, leading zeros, both in the location and in the instruction, do not have to be typed. If you want the system to add an increment to the location automatically, type xxx+yyyyyy. When the automatic increment is in effect, the system displays the next location after accepting the previous entry. Then type only the instruction. To terminate the automatic increment, press the erase key after the location appears.

3. If you want to store the program displayed in RAM for future use; type SP n (0 through 3 octal) which is the RAM program number.

PROCEDURE 4-5. DEADSTART PROCEDURE, COLDSTART (ISMT SUBSYSTEM)

Do the following steps for the coldstart of a 63X Intelligent Small Tape Unit (ISMT). The coldstart loads peripheral microcode from the CIP tape into the tape unit adapter. Once the tape unit has been coldstarted, follow the warmstart procedure described later in this section.

1. Apply power to the 63X tape unit.
2. Mount the CIP tape on the tape unit.
3. Place the tape unit on line.
4. Activate the initial deadstart display by performing procedure 4-3.
5. Enter the coldstart program by performing procedure 4-4. The required program is the 63X ISMT subsystem coldstart program from table 3-1.
6. Coldstart by typing either S or L, followed by a carriage return. The screen goes blank and remains blank.
7. To determine whether coldstart occurred, perform the following steps:
 - a. Do procedure 4-3 to again bring up the initial deadstart display.
 - b. Type CH to bring up the channel status display. Coldstart is complete when the channel used for the coldstart goes inactive.

Upon receipt of the 60u function, the tape unit adapter:

- a. Executes internal diagnostics.
 - b. Connects to the 63X streaming tape unit.
 - c. Rewinds the tape unit.
 - d. Reads the 63X microcode record from tape.
 - e. Verifies the microcode ID and revision level.
 - f. Performs a checksum of the microcode.
 - g. Executes the microcode diagnostics.
 - h. Rewinds the tape if all of the above execute properly.
8. To verify proper loading of the microcode or to identify the cause of a bad load, perform the following steps.
 - a. Wait for tape motion to stop or wait ten seconds if the tape did not move.
 - b. Activate the initial deadstart display by doing procedure 4-3.
 - c. Type PR followed by a carriage return. The PP register display appears.
 - d. If P equals 0012, the cause could be the wrong channel number, a 60u function parity error, a bad CYBER channel, a bad adapter channel interface, ROM diagnostic failure, or RAM memory test failure.
 - e. If P equals 0014, the cause could be a 012 function parity error, bad adapter interrupt logic, or a bad adapter channel interface.

- f. If P equals 0016, type PM followed by a carriage return. The PP memory display appears. Examine location 0030.
- g. If location 0030 equals 1000, the microcode is loaded and initialized correctly, and the tape unit is ready for use.
- h. If location 0030 does not equal 1000, an error has occurred. Refer to the following table:

<u>Contents of Location 0030</u>	<u>Possible Failing Condition</u>
5220	Bad microcode ID
5221	Bad microcode checksum
5222	Bad microcode initialization
5223	Microcode diagnostics error
5226	Cannot find the microcode on the tape
5227	Unrecoverable error on the microcode record
5243	Cannot connect to the tape unit
5244	Cannot rewind the tape unit

- 1. If the contents of location 0030 are not shown in the above table, refer to Appendix E of the Intelligent Small Magnetic Tape (ISMT) Subsystem Reference Manual for a full description of the general status codes.

PROCEDURE 4-6. DEADSTART PROCEDURE, COLDSTART (ISD SUBSYSTEM)

This procedure summarizes the steps necessary to coldstart an ISD subsystem by loading factory-installed peripheral microcode on a small disk onto the disk adapter and control module. Once the ISD subsystem has been coldstarted, do the warmstart procedure described later in this section to complete the deadstart. Proceed as follows:

- 1. Activate the initial deadstart display by performing procedure 4-3.
- 2. Enter the coldstart program by performing procedure 4-4. The required program is the ISD subsystem deadstart program from table 3-1.
- 3. Coldstart by typing either S or L, followed by a carriage return. The screen goes blank and remains blank.
- 4. To determine whether coldstart occurred, perform the following steps:
 - a. Activate the initial deadstart display by doing procedure 4-3.
 - b. Type CH to bring up the channel status display. Coldstart is complete when the channel used for the coldstart goes inactive.

PROCEDURE 4-7. DEADSTART PROCEDURE, COLDSTART (66X/7152 TAPE CONTROLLER FROM TAPE)

Do the following steps for the coldstart of a 66X tape unit and 7152 controller when the peripheral microcode is on tape. Once the tape unit has been coldstarted, follow the warmstart procedure, described later in this section to complete the deadstarting.

- 1. Remove write enable ring from the CIP deadstart tape.
- 2. Mount the tape and ready the unit.
- 3. Activate the initial deadstart display by performing procedure 4-3.
- 4. Enter the coldstart programs by performing procedure 4-4. The required program is the 7152 controller from tape deadstart program in table 3-1.
- 5. Coldstart by typing either S or L, followed by a carriage return. The screen goes blank and remains blank.
- 6. To determine whether coldstart occurred, perform the following steps:
 - a. Activate the initial deadstart display by performing procedure 4-3.
 - b. Type CH to bring up the channel status display. Coldstart is complete when the channel used for the coldstart goes inactive.

PROCEDURE 4-8. DEADSTART PROCEDURE, COLDSTART (844/7152 DISK CONTROLLER FROM DISK PACK)

Use the following steps for the coldstart of a 844 tape unit and 7152 controller when the peripheral microcode has been prerecorded on an 844 disk pack using utility LDC. Once the disk unit has been coldstarted, use the warmstart procedure described later in this section to complete the deadstarting.

- 1. Load the disk pack containing the peripheral microcode.
- 2. Activate the initial deadstart display by performing procedure 4-3.
- 3. Enter the coldstart program by performing procedure 4-4. The required program is the 7152 controller from disk deadstart program.
- 4. Type a S or an L to coldstart the tape controller.
- 5. Coldstart by typing either S or L, followed by a carriage return. The screen goes blank and remains blank.

6. To determine whether coldstart occurred, perform the following steps:
 - a. Activate the initial deadstart display by doing procedure 4-3.
 - b. Type CH to bring up the channel status display. Coldstart is complete when the channel used for the coldstart goes inactive.

PROCEDURE 4-9. DEADSTART PROCEDURE, WARMSTART

Perform the following steps to deadstart from a 66X or 67X tape unit, or from an 834, 844 or 885 disk unit. The required peripheral microcode is assumed to be loaded and functioning properly.

NOTE

After power has been off on a controller, a coldstart is required before the warmstart can be done.

1. Mount the CIP deadstart tape or disk pack (refer to operating system operator's guide for instructions).
2. Activate the initial deadstart display by doing procedure 4-3.
3. Enter the deadstart program by doing procedure 4-4. The required program is one of the two warmstart programs from table 3-2 depending on the channel used.
4. To warmstart the system, type either S or L and press CR. Type S for a short deadstart (no testing on IOU is performed); type L for a long deadstart (testing on IOU is performed). Long deadstart is normally done after application of power to the mainframe or after system maintenance initial options. The Initial Options Display appears (see CIP User's Handbook).
5. After the initial options display appears, continue using the CIP User's Handbook.

PROCEDURE 4-10. POWER-ON INITIALIZATION

Perform a power on initialization when deadstarting the computer system and after applying power to the mainframe.

NOTE

Skip steps 1 through 3 if the system deadstart program number 3 is automatically retrieved when system power is applied to the mainframe. (See Power Recovery Deadstart Program below.)

1. Perform the required coldstart procedure 4-5 through 4-8, if necessary, to ensure peripheral microcode is installed.
2. Perform steps 1 through 3 of warmstart procedure 4-9.
3. Enter an L and press CR to initiate a long deadstart. Initial options display appears.
4. Enter letter U and press CR. The utilities display appears.
5. Enter the letter I. The initial options display reappears with the following message at the bottom of the screen:

ALL MAINFRAME MEMORIES WILL BE
INITIALIZED FOR MSL/OS LOADS.

6. Enter one of the following:

CR To initialize the system (deadstart recovery level) and load the operating system. If the deadstart recovery level is 1, 2, or 3, the following message appears:

OS LOAD IMPOSSIBLE
POWER ON INITIALIZATION
AND RECOVERY DEADSTART
SELECTED DEADSTART AND
SELECT ONLY ONE OPTION.

Refer to the operating system operator's guide for information regarding recovery levels.

M To initialize the system and bring up the initial CMSE deadstart display.

7. If communication with a PP is lost during initialization, the following message appears:

PP xx NOT RESPONDING
DEADSTART ABORTED

Activate initial deadstart display, logically turn off the PP using FI xx command (force idle PP number xx) and repeat the procedure.

POWER RECOVERY DEADSTART PROGRAM

Deadstart program number 3 in microprocessor RAM is designed for use after a system power on. When system power is applied to a CYBER 180 Model 810 or 830 mainframe, program 3 is automatically retrieved, and may initiate a long deadstart sequence. If you desire this feature, store the required deadstart program as program number 3 (procedure 4-4 with SP 3 in step 3). If this feature is not desired, store program 3 with the first word as 000300. This instruction puts PPO into a hang state.

CALENDAR CLOCK

The calendar clock card incorporates a battery; therefore, it is not normally necessary to reset the calendar clock after a power interruption. If no calendar clock readout is available during the loading of an operating system, the operator is prompted to enter current year, month, day, hour and minute.

SECTION 5

PROBLEM DETERMINATION

This section contains instructions for performing certain maintenance procedures prior to contacting the on-call CE.

Maintenance assistance will be required in three situations:

1. The operating system displays a fatal error message and the system cannot be recovered or restarted.
2. The system does not deadstart.
3. A power or cooling failure has occurred.

The following troubleshooting guides has been developed to assist in these situations. Its intent is, first of all, to attempt system recovery so that operation can continue until the on-call CE is contacted, and, secondly, to provide a clear picture of the failing situation to the on-call CE through use of the preservice request form.

STRUCTURED ANALYSIS METHOD (SAM)

This section uses structured analysis method (SAM) lists to guide the troubleshooting process. Figure 5-1 shows the SAM format. To interpret a SAM, read the advisory information (if any) following the SAM title, then go to the first question. If the answer is yes, follow the line below the Y to the next question or action. If the answer is no, follow the line below the N. Actions are numbered sequentially, and the number of the last action in a sequence is underlined.

It may not be necessary to perform all the actions listed under a specific question. Proceed only until desired result is accomplished. For example, in SAM 5-1, there is no need to do step 4 if step 3 resulted in a successful recovery.

Procedures referenced in these lists are located in sections 3, 4, 5, and 6 of this guide, in the operating system operator's guide, and in the CIP User's Handbook.

SAM 5-1. OPERATING SYSTEM ERROR MESSAGES

Steps to take when the operating system halts and displays a fatal mainframe error message at the system control point of the B display are stated in the following SAM:

010	Y	N	CM	FATAL ERROR message?
020	:	Y	N	CPU FATAL ERROR message?
030	:	:	Y	IOU FATAL ERROR message?
040	:	:	Y	N MCH FATAL ERROR message?
050	:	:	:	<u>1</u> No fatal errors. Attempt level 3 recovery deadstart as described in the operating system operator's guide. If errors occur, go to SAM 5-2.
	:	:	:	
060	1	1	1	1 Record error message on preservice request form.
	:	:	:	:
070	2	2	2	2 Take express deadstart dump. Refer to CIP User's Handbook.
	:	:	:	:
080	3	3	3	3 Attempt level 3 recovery deadstart as described in operating system operator's guide.
	:	:	:	:
090	4	4	4	4 Run hardware initialization and verification software (HIVS) according to procedure 5-1. Record errors on preservice request form.
	:	:	:	:
100	5	5	5	5 Attempt level 0 recovery deadstart as described in operating system operator's guide.
	:	:	:	:
110	6	6	6	6 Dump maintenance registers. Select print options K, L, and M. Attach printout to preservice request form.
	:	:	:	:
120	7	7	7	7 Load off-line maintenance software according to procedure 5-2.
	:	:	:	:
130	8	9	9	8 Run memory tests command buffer according to procedure 5-3. Record messages on preservice request form.
	:	:	:	:
140	9	10	8	8 Run IOU tests command buffer according to procedure 5-3. Record messages on preservice request form.
	:	:	:	:
150	10	8	:	8 Run processor tests command buffer according to procedure 5-3. Record messages on preservice request form.
	:	:	:	:
160	11	:	:	11 Degrade central memory according to procedure 3-2.
	:	:	:	:
170	:	10	:	10 Reconfigure PPs according to procedure 3-1.
	:	:	:	:
180	12	11	:	11 Attempt level 0 recovery deadstart as described in the operating system operator's guide.
	:	:	:	:
190	13	11	12	9 Contact service center.
200	<u>14</u>	<u>12</u>	<u>13</u>	<u>10</u> Establish remote maintenance terminal communication described in procedure 5-5.

SAM 5-2. DEADSTART ERROR MESSAGES

SAM 5-2 guides the operator through the steps to take when an error occurs during a system deadstart sequence.

010	Y	N				PROCESSOR NOT RESPONDING, FATAL ERROR - DEADSTART ABORTED message?	
020	:	Y	N			DEADSTART ABORTED - FATAL ERROR message?	
030	:	:	Y	N		ERROR PP xx message?	
040	:	:	:	Y	N	ERROR CM message?	
050	:	:	:	:	Y	N	ERROR CPUxx message?
060	:	:	:	:	:	1	No messages but sequence halted. Record deadstart status.
070	1	1	1	1	:	:	Record error message on preservice request form.
080	2	:	:	:	:	:	Deadstart. Turn off falling PP according to procedure. Press CR to load the operating system.
090	3	2	:	:	:	:	Dump maintenance registers. Refer to CIP User's Handbook. Select print options K, L, and M. Attach printout to preservice request form.
100	:	3	:	:	:	:	Run hardware initialization and verification software (HIVS) according to procedure 5-1. Record errors on preservice request form.
110	:	4	:	:	:	:	Attempt level 0 recovery deadstart as described in the operating system operator's guide.
120	4	5	2	2	2	:	Load off-line maintenance software according to procedure 5-2.
130	5	6	3	4	:	:	Run IOU tests command buffer according to procedure 5-3. Record messages on preservice request form.
140	:	7	4	3	4	:	Run memory tests command buffer according to procedure 5-3. Record messages on preservice request form.
150	:	8	:	5	3	:	Run processor tests command buffer according to procedure 5-3. Record messages on preservice request form.
160	:	:	:	6	:	:	Degrade central memory according to procedure 3-2.
170	:	:	:	7	:	:	Attempt level 0 recovery deadstart as described in the operating system operator's guide.
180	6	9	5	8	5	<u>2</u>	Contact service center.
190	<u>7</u>	<u>10</u>	<u>6</u>	<u>9</u>	<u>6</u>		Establish remote maintenance terminal communication described in procedure 5-5.

SAM 5-3. POWER/COOLING WARNING MESSAGE OR FAILURE CONDITIONS

Steps to take when power or cooling system failures occur or a shutdown is imminent are stated in the following SAM:

010	Y	N				CPU POWER FAILURE message?	
020	:	Y	N			SHUTDOWN IMMINENT message?	
030	:	:	Y	N		Mainframe powered down?	
040	:	:	:	Y	N	Audible warning sounded?	
050	:	:	:	:	:	<u>1</u>	No warning message or failure occurred.
060	1	1	:	:	:	:	No action will prevent automatic power down. To lessen impact, perform the procedures in section 6.
070	:	:	:	:	:	<u>1</u>	Contact building maintenance personnel.
080	:	:	:	1	:	:	Look at the voltage meter inside each bay to determine which unit has powered down. Meter should indicate 0 percent when unit is on.
							NOTE
							Set meter select switch is positioned to other than OFF position.
090	2	2	2	:	:	:	After cooling system or unit has powered down, record power and cooling status on preservice request form.
100	3	3	:	:	:	:	Press POWER ON switch on system power control panel to bring power back up on system.
110	:	:	:	3	:	:	Attempt to bring power back up on unit according to procedure 4-2.
120	:	:	:	4	:	:	Perform an initial deadstart to reload the operating system as described in the operating system operator's guide. Coldstart is required for ISD and ISMT.
130	<u>4</u>	<u>4</u>	<u>4</u>	<u>5</u>			Contact service center.

MAINTENANCE PROCEDURES

All sites are supplied with a hardware initialization and verification sequence (HIVS). Sites with a maintenance contract are also supplied with MSL 151 which consists of a set of tests and diagnostics which aid the checkout and isolation of defective components in the computer system. The MSL contains the common maintenance software executive (CMSE), tests, diagnostics, and utility programs.

Option M of the CTI initial options display loads the CMSE deadstart loader program. CMSE then allows operation on individual tests, diagnostics, or utilities by providing test displays, a keyboard command structure, a loading capability, and diagnostic sequencing.

PROCEDURE 5-1. RUN HARDWARE INITIALIZATION AND VERIFICATION SEQUENCE (HIVS)

The hardware verification sequencer of HIVS controls the execution of a set of go/no go tests of the peripheral processor subsystem (PPS), CM, extended memory (EM), and the CPU. The tests are taken from the MSL and run under control of the sequencer using the capabilities of the CMSE. The tests executed are CMC, MY1, EJP, and CT8.

Use this procedure to initiate the hardware verification sequence of HIVS. This procedure assumes you have deadstarted the system and have selected the OS LOAD WITH INTERVENTION on the CTI initial options from disk display.

NOTE

If you want a level 3 recovery and want to verify the hardware, set the deadstart program for a level 3 recovery prior to deadstart.

PARAMETERS	
*CM	400000
RA/100	0
FL/100	4000
*CPU-0	
*CPU-1	
*PPS	
EM	
EMRA	2120
EMFL	1700

Figure 5-1. HIVS Display

1. Enter V to select HIVS. Display shown in figure 5-1 appears. Asterisks (*) on this display indicate hardware to be tested.
2. Add or delete hardware tests using one or more of:

<u>Entry</u>	<u>Description</u>
A,CM or D,CM	Add (A) or delete (D) central memory tests
A,CO or D,CO	Add or delete CPU-0 tests
A,C1 or D,C1	Add or delete CPU-1 tests
A,PS or D,PS	Add or delete PP tests

When a test is selected on hardware that is turned OFF via CTI or is physically not present, following messages display:

NO PP AVAILABLE
NO CM AVAILABLE
NO CP AVAILABLE

3. Press CR to start testing. Hardware testing sequences can be selected individually. They are not dependent on successful completion of previous tests. For example, CPU testing can be selected and executed without testing PPs or CM; PP testing can be deselected and all other testing still executes. HIVS displays following messages during testing sequence:

TESTING REG
TESTING PPS
TESTING CM
TESTING CPU xx
TESTING EM

If test sequence completes without detecting errors, HIVS displays:

HARDWARE VERIFICATION COMPLETE
DEADSTART IS REQUIRED

4. If error is detected, HIVS displays one of the following error messages:

ERROR PP xx
ERROR CM
ERROR CPU xx
ERROR REG

where xx indicates the PP or CPU in error.

PROCEDURE 5-2. LOAD OFF-LINE MAINTENANCE SOFTWARE

The following steps are performed when deadstarting the maintenance software from a 63X, 66X, or 67X tape unit, or an 834, 844, or 885 disk unit. The procedure assumes necessary peripheral microcode has been loaded and is functioning.

1. Mount CIP tape or disk. See operator's guide for instructions.
2. Initiate a deadstart using procedure 4-3; enter program for warmstart (table 3-2).
3. Type S for short deadstart. Initial options display appears on screen.
4. Type M. Off-line maintenance deadstart display shown in figure 5-2 appears for a tape deadstart. Refer to notes below this figure for a description of disk deadstart display.

S1 MAINT. SYS
 COPYRIGHT CONTROL DATA CORP., 1979
 (CR) TO LOAD SYS
 MNE - LD STAND-ALONE TST

KP - CLR PPS
 KC - CLR CM
 NN.ENTRY (CR) - CHG SYS CONFIG

SYS CONFIG

1. MACHINE TYPE = S1
 2. CM SIZE+ = 05
 3=365K 4=98K 5=131K
 6=198K 7=262K
 3. EM SIZE+ = 0X
 1=1XXK 2=2XXK 3=5XXK 4=10XXK
 5=15XXK 6=20XXK 12=40XXK
 4. NO. OF CPUS+ = 01
 5. NO. OF PP S+ = 24

6. MON PP/IO COMM CH = 01
 7. PP COMM CH = 03
 8. DIS PP/COMM CH = 02
 9. SCAN CH(CY176 ONLY) = 00
 10. FLPP(CY 176 ONLY) = 0000
 11. LD DEV TYPE = 00
 0=TAPE,1=844-21,2=3330-1,3=3330-11
 4=3350,5=844-4X,6=885,7=834
 12. 405 (CCEE)* = 1204
 13. CM FLAG/CR MAC/DCC* = 4401
 14. TAPE UN/DCC NO.S(UUOD)** = 0101
 15. DISK CH AND EQ** = 0100
 16. DISK UN/MAC/DCC NO.S(UUMD) = 0100
 17. DISK CYL NO. = 0000

NOTES

- + Entry not applicable on some machines.
- ++++ Display is divided here for tabletop console.
- * Entry not displayed if tape deadstart (entries are renumbered).
- ** Entry not displayed if disk deadstart (entries are renumbered.)

Figure 5-2. MSL Deadstart Display

5. To change an entry, enter:

nn.entry

where:

nn number of entry to be changed.

entry desired value described on display.

Press CR.

6. Press CR when all entries are correct. CMSE A display header appears on left screen and B display header appears on right screen shown in figures 5-3 and 5-4 (21-inch model). Both headers are combined for the tabletop console shown in figure 5-6 CH/PP display.

CMSE is now operational and ready to execute tests and diagnostics directed by operator commands.

```
CR OFF CPO PP03 04 05 06 07 10 11
F S S F*E D*E P * D* * F *
LE CPl PP20 21 22 23 24 25 26 27 30 31
A=0000 OFF * * * * * * * * * *
```

Figure 5-3. CMSE A Display Header (21-Inch Model)

The following status characters may appear in the A display header:

Display	Meaning
*	PP or CP is in contact with CMSE.
A	PP that was last automatically assigned.
D	PP or CP requests test display.
E	PP or CP identifies an error condition.
F	CMSE unable to contact PP in 4096 attempts.
I	PP is idle, available for use.
P	PP has parity error status.
LE	Displays when error logging is turned on.
F S S	Clock margins: fast (F) and slow (S), maximum of three.
A=0000	Indicates contents of pseudo A register.
CPx	CPU x
OFF	CMSE is not monitoring for calls in central memory.

PPs which do not exist or are not available for maintenance do not appear in header display. Keyboard area consists of bottom five lines of A display.

```

CH00 01 02 03 04 05 06 07 10 11 12 13 15 17
     E00 -00 - F00 - -10 - - F00 - - - - -
CH20 21 22 23 24 25 26 27 30 31 32 33
     - - - - F07 - - - - P - -
BP
ST SS SB SC *SE LE RT RS RB RC SM QL DR DE

```

Figure 5-4. CMSE B Display Header

B display shown in figure 5-4 contains system error and I/O channel status information as follows:

Display	Meaning
-	Channel inactive when interrogated by CMSE
F	Channel full when interrogated by CMSE
E	Channel empty when interrogated by CMSE
P	Channel contains parity error status
BP	Display descriptor specifies type of display

Number following the hyphen, E, or F channel activity indicator is number of PP for which channel is reserved. If 00, channel is reserved for CMSE use.

In bottom line of header display, an asterisk indicates selected parameter conditions.

The A display header and the B display header described for the 21-inch model displays are combined into a single operator-selectable display on the tabletop model. This display, called the CH/PP display, is shown in figure 5-6. Entry of a dollar sign (\$) or the F2 key select this display.

```

CR OFF *CPO PP 01 04 05 08 07 10 11
      OFF I I I I I I I I
      CP1 PP 20 21 22 23 24 25 26 27 30 31
A=0000 OFF I I I I I I I I I I I

```



```

CH00 01 02 03 04 05 06 07 10 11 12 13 15 17
     - -00 E00 F00 E00 E E E F E E
     - - - -
CH20 21 22 23 24 25 26 27 30 31 32 33
     E E E E E E E E E E E E

```

Figure 5-6. CH/PP Display (Tabletop Model)

PROCEDURE 5-3. RUN COMMAND BUFFERS

Command buffers are a means of saving strings of CMSE and program commands which are necessary to execute a particular diagnostic sequence. An operator can easily access a specific command buffer by entering one command.

Use this procedure to load and run a command buffer. This procedure assumes maintenance software library has been loaded and is operational as described in procedure 5-2.

1. Type D from initial deadstart display and record error if any.
2. Redeadstart and reinitialize CMSE.
3. Type go, F1110.
4. If command buffer halts, press CR.
5. Record errors on preservice forecast sheet.
6. Repeat steps 2-5 for command buffers CMI10 and FIS10.

Test and diagnostic display (figure 5-5) appears while tests are running.

name op PCxxxx Sxxxx SBxxxx Cxxxx - (message)

Figure 5-5. Test and Diagnostic Message Display

In figure 5-5, the following nomenclature is used:

name	Name of test (four-character mnemonic)
op	Type of operation performed:
	RU Running
	SM Scope mode
	SP Set parameters/stopped for parameters
	SC Stop at end of condition
	SL Stop at loop
	SB Stop at end of subsection
	SS Stop at end of section
	ST Stop at end of test
	SE Stopped on error
	RC Repeating condition
	RL Repeating loop
	RB Repeating subsection
	RS Repeating section
	RT Repeating test
PCxxxx	Pass count
Sxxxx	Current section number
SBxxxx	Current subsection number
Cxxxx	Current condition number

PROCEDURE 5-4. DISPLAY COMMAND BUFFER NAME TABLE

The maintenance software library contains a number of command buffers for the convenience of operators and CEs who wish to use the tests, diagnostics, and utilities on the MSL.

Use this procedure to display a list of available command buffers. This procedure assumes maintenance software library has been loaded and is operational as described in procedure 5-2.

1. Type AG or BG command. Press CR.
A or B screen displays up to 200 command buffer names.
2. Enter AG,indx or BG,indx to advance table. Press CR. Table advances by number of entries indicated by indx (1 to 4 octal digits). Entry of + increments name table display. Entry of - decrements name table display.

REMOTE MAINTENANCE COMMUNICATIONS

When the service center is contacted for maintenance assistance, the technical support CE may ask that communication be established with a remote maintenance terminal.

Perform the following procedure to establish communication with the remote terminal and load and initiate execution of the RTD program.

NOTE

This procedure assumes that:

- An acoustic coupler has been installed on the two-port multiplexer at your site.
- Two telephones are available at your site.

PROCEDURE 5-5. ESTABLISH REMOTE MAINTENANCE COMMUNICATION USING RTD

1. Verify with the CE that the acoustic coupler and cable are installed correctly to the telephone.
2. Turn acoustic coupler power on.
3. Load the off-line maintenance software library using procedure 5-2.
4. Type GO,RTD and CR to load RTD.
5. Press the space bar to start RTD operation.

6. Using a second telephone, establish communications with the remote terminal as directed by the technical support CE.

When remote communication has been established, you can continue to use the first telephone to communicate with the CE for additional instructions or you can enter and receive messages as the system console if you have a CC545 console.

7. To enter console messages, type MSG=x.....x where x is a maximum of 56 characters.

NOTE

Do not enter any other keyboard commands as they may be interpreted as CMSE commands by the system and disrupt remote maintenance operation.

The following error messages may appear if an error condition is detected while initiating RTD and establishing communication with the remote terminal:

DRIVER NUMBER INCORRECT
WAITING FOR CHANNEL
CHAR REJ TIMEOUT
NO CARRIER ON
CI NOT READY
DSR NOT UP
CH ACT AFTER FUNC

8. Contact the CE for additional instructions if any of these messages appears on the display.

PROCEDURE 5-6. ESTABLISH REMOTE MAINTENANCE COMMUNICATION USING L.R.

1. Verify with the C.E. that the acoustic coupler and cable are installed correctly to the telephone.
2. Turn acoustic coupler power on.
3. Establish voice communication via second telephone with C.E.

SECTION 6

EMERGENCY OPERATING INSTRUCTIONS

This section provides procedures to be performed under emergency or abnormal operating conditions.

PROCEDURE 6-1. EMERGENCY POWER REMOVAL

Set the red EMERGENCY switch on the front door of the mainframe to OFF (down).

NOTE

This switch is for emergencies only.

Setting the EMERGENCY switch to OFF trips the 50/60 HZ DISCONNECT, AC TO DC CONVERTER INPUT, and BATTERY DISCONNECT circuit breakers. The EMERGENCY switch must be in the up position before resetting these circuit breakers. The unit emergency off is independent of the room emergency off. It affects only the mainframe.

The emergency circuits of two model 810, 810A, 65810, 830, 830A and 65830 systems can be connected. In this case, activating the emergency circuit at either system removes power from both systems.

PROCEDURE 6-2. AUDIBLE ALARM

The audible alarm indicates that room temperature has reached 35°C (95°F). Contact building maintenance personnel.

SECTION 7

POWER DOWN

This section provides normal power down procedures. Before performing these procedures, refer to the applicable operating system operator's guide for procedures on preparing the operating system for a normal shutdown.

PROCEDURE 7-1. POWER REMOVAL, NORMAL CONDITION

Normal power removal procedures vary depending on whether system power is under remote or local control.

LOCAL CONTROL

Press and release OFF on mainframe cabinet power control panel. Cabinet power is removed.

SPCP CONTROL

Press STOP button on SPCP or, at mainframe cabinet power control panel, turn CONTROL switch to LOCAL and press CABINET POWER OFF switch.

CAUTION

Keep EMERGENCY switch on under all normal conditions.

Remove power from system according to type of remote control:

REMOTE 1 Do one of the following as applicable:

- a. Contact CE to remove power from master CYBER 180 model (powers down both master and slave systems); or, remove power from slave system only described under SPCP Control above.
- b. Contact CE to remove power from master CYBER 180 model. Power down slave CYBER 180 Model 810 or 830. If mode switch on slave system SPCP is in LOCAL position, remove power from slave system described under LOCAL CONTROL above.

REMOTE 2 Remove power from master CYBER 180 Model 810, 810A, 65810, 830, 830A and 65830 described under LOCAL CONTROL, above (powers down both master and slave systems); or, remove power from slave system only described under LOCAL CONTROL above.

REMOTE 3 Reserved for future use.

SECTION 8

OPERATOR SUPPLIES

PRESERVICE REQUEST FORM

The preservice request form shown in figure 8-1 documents the visible indications of a hardware failure. It provides the CE with a written record of the problems you encountered and the procedures

you performed in attempting to identify and correct the problems.

With this information, the on-call CE can determine which tools, test equipment, and spare parts to bring on the service call.

PRESERVICE REQUEST FORM

Customer Name _____ Date _____ Time _____

OPERATING SYSTEM STATUS

Operating System Error Message _____

TEST OR DIAGNOSTIC STATUS

Command Buffers Run (List All Command Buffers Run)

Buffer Command	Failed?	Test	Sec(s)	Subsec(sb)	Cond (C)	EC1	EC2
_____	_____	_____	_____	_____	_____	_____	_____
_____	_____	_____	_____	_____	_____	_____	_____
_____	_____	_____	_____	_____	_____	_____	_____

Error Message _____

DEADSTART STATUS

Initial Display: Proper _____ Garbage _____ None _____ DS PROG WORD 12 _____

LDS Display _____ PP REG DISPLAY AT ERROR STOP

PPM Config	PP No.	P	A	Q	K
_____	00	_____	_____	_____	_____
BRL Config	01	_____	_____	_____	_____
_____	02	_____	_____	_____	_____
Delay Loop	03	_____	_____	_____	_____
_____	04	_____	_____	_____	_____
_____	05	_____	_____	_____	_____
_____	06	_____	_____	_____	_____
_____	07	_____	_____	_____	_____
_____	10	_____	_____	_____	_____
_____	11	_____	_____	_____	_____

Error Message _____

Warning Message _____

Printouts Attached _____ Printer Dump _____ Error Logs _____

Express Dump Available (Y/N) _____ Tape _____ Location _____

Listing _____ Location _____

Operator

Phone

Figure 8-1. Preservice Request Form (Sheet 1 of 3)

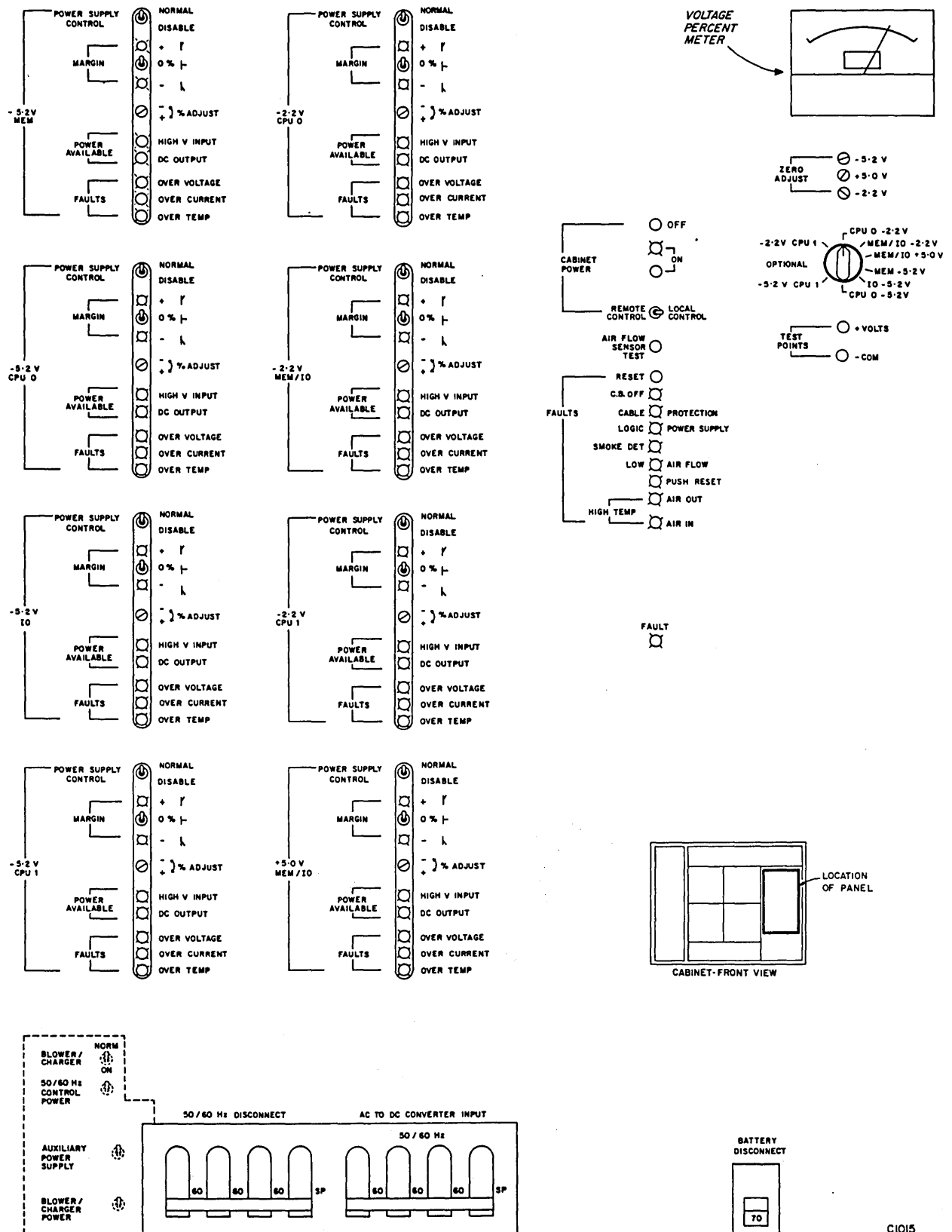

Figure 8-1. Preservice Request Form (Sheet 2 of 3)

MARK ANY LIT RED LIGHTS AND TRIPPED CIRCUIT BREAKERS.

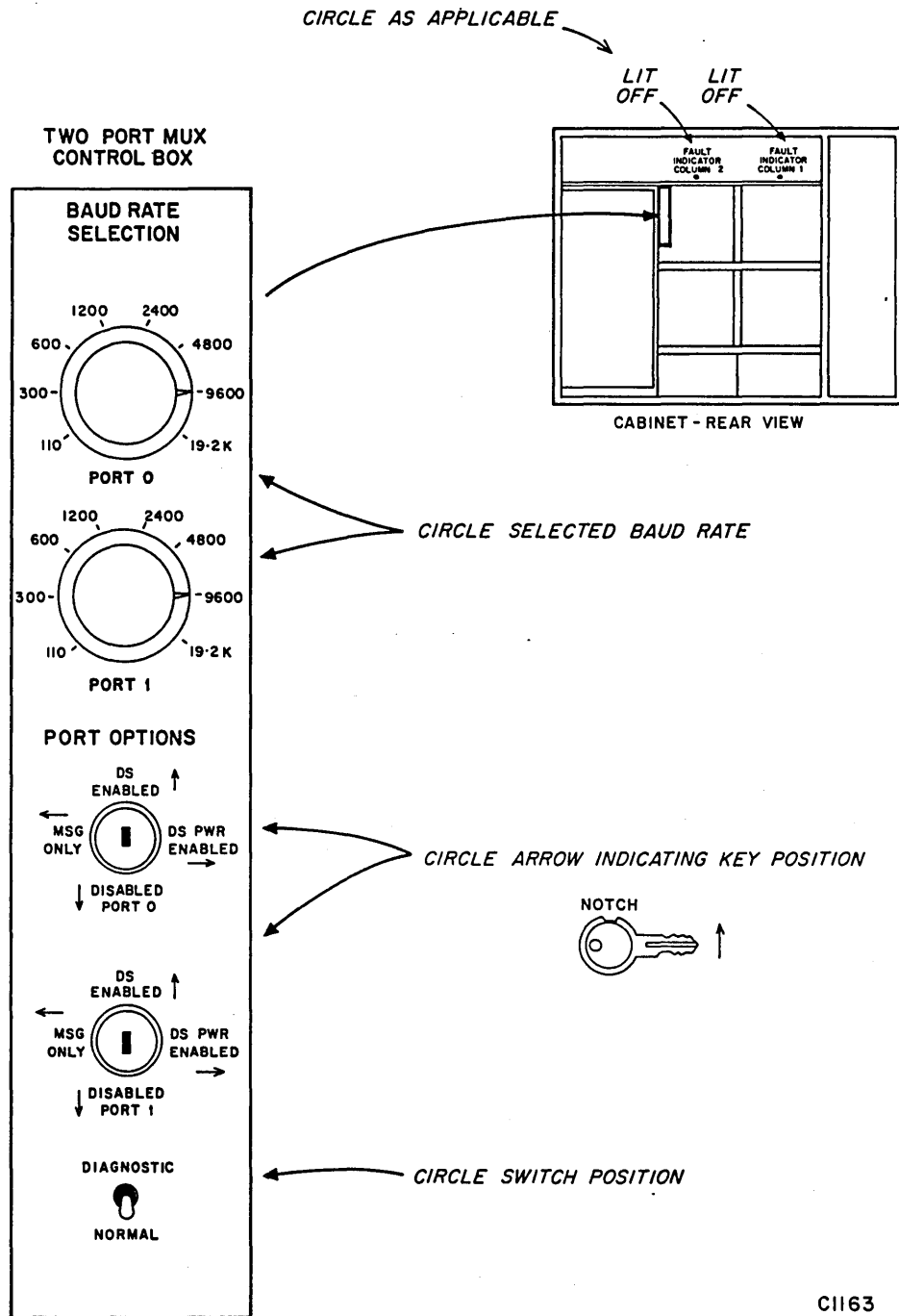

Figure 8-1. Preservice Request Form (Sheet 3 of 3)

Please fold on dotted line;
seal edges with tape only.

FOLD

FOLD

FOLD



BUSINESS REPLY MAIL

First-Class Mail Permit No. 8241 Minneapolis, MN

POSTAGE WILL BE PAID BY ADDRESSEE

CONTROL DATA

Technical Publications
ARH219
4201 N. Lexington Avenue
Arden Hills, MN 55126-9983

NO POSTAGE
NECESSARY
IF MAILED
IN THE
UNITED STATES

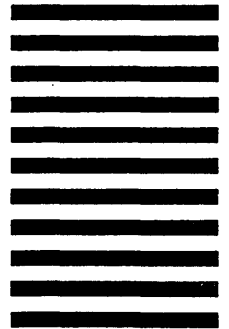

COMMENT SHEET

MANUAL TITLE: CYBER 180 Models 810 and 830 Computer Systems
Hardware Operator's Guide.

PUBLICATION NO.: 60469440

REVISION: C

NAME: _____

COMPANY: _____

STREET ADDRESS: _____

CITY: _____ **STATE:** _____ **ZIP CODE:** _____

This form is not intended to be used as an order blank. Control Data Corporation welcomes your evaluation of this manual. Please indicate any errors, suggested additions or deletions, or general comments below (please include page number references).

CUT ALONG LINE

FOLD ON DOTTED LINES

CORPORATE HEADQUARTERS, P.O. BOX 0, MINNEAPOLIS, MINN 55440
SALES OFFICES AND SERVICE CENTERS IN MAJOR CITIES THROUGHOUT THE WORLD

LITHO IN U.S.

 CONTROL DATA